



caesar

CAESAR.COM.VN

caesar

CATALOGUE 2020

caesar

2020

PRODUCT SIZE EXPLANATORY

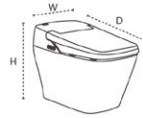

E.FANCY

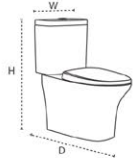

TOILET

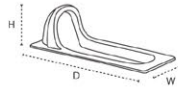

TOILET

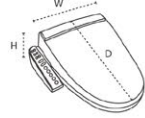

TOILET SEAT

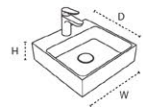

SINK

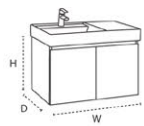

SINK

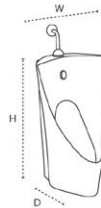

URINAL

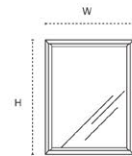

ACCESSORY

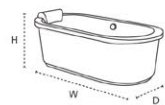

BATHTUB

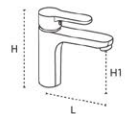

FAUCET

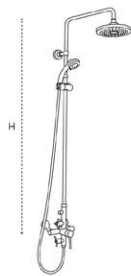

SHOWER

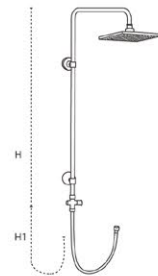

SHOWER

Chú ý : - Công ty chúng tôi được quyền thay đổi giá cả - màu sắc - kích thước - kiểu dáng và chức năng của sản phẩm.
- Hình ảnh trong catalogue này chỉ mang tính chất minh họa.

CONTENTS

5	Technology
7	Craftsmanship
17	Toilet
67	Sink
125	Urinal
142	Faucet & Shower
211	Bathtub
245	Accessory
269	Drawing
296	Installation

Inspire
Dream
Believe



BE THOUGHTFUL
POSITIVE
GRATEFUL



TECHNOLOGY



FINE FIRECLAY FORMULATION
Edge, slimmer and modern design available with Caesar's Fine Fireclay formulation



NANO PROTECT
Nano protect technology partnered with TANIDA to provide antibacterial and anti-smudgy products



RIMLESS DESIGN
Revolutionary rimless toilet design makes every day cleaning easier and faster



ROUGH-IN CONNECTOR
Rough-in connector gives you flexibility over various rough-in sizes



CERAMIC DRAIN COVER DESIGN
Ceramic drain cover does not only looks good but is also practical



AIR-IN TECHNOLOGY
Smooth aerated water with water-saving advantage in Caesar shower collections



TPR EASY CLEAN MATERIAL
Easy to clean material for hand shower head



TEMPERATURE CONTROL TECHNOLOGY
Temperature control system to upgrade your showering experience



FLUSHING TECHNOLOGY
Outstanding wash-down and siphon flushing system for you to choose



ANTIBACTERIAL MATERIAL
SIAA certified inhibition of proliferation of bacteria on the surface of toilet seat



MAGIC POWER TECHNOLOGY
Revolutionary hydropower system for urinal / faucet collections



TOUCH FREE TECHNOLOGY
Sensor control in urinal / toilet / faucet products for better sanitation



SAFETY TESTED
All wall-hung basin products went through a 10 minutes loading test of 113.4kg.



ECO SAVING VALVE
Smart faucet valve design to avoid accidental trigger of heating system



LEAD FREE ALLOY (< 0.25%)
An International standard of lead free faucet collections (< 0.25%)



CU FREE PROCESS
An environmental friendly production process for mirror products (Lead free / Cu free)



SMART SENSOR
IOT capability detecting usage and preventing false flushes



CAESAR-SHIELD applies world-class technologies of antibacterial and antiviral materials to protect you and your family.



PURIFY O3 SANITIZER
is a simple and effective way to achieve hospital-grade disinfection for your environment.

CERTIFICATION





It Begins In Our Hands And Ends In Yours



We grain and mix kaolin with a variety of ingredients, the end mixture becoming the base material for our porcelain products.

PURIFY AND TRANSFORM

In the 18th century, porcelain from China (Jingdezhen porcelain) was considered white gold in Europe, where nobility and royalty would spend large fortunes to acquire it. At the time, Europeans did not know how to produce porcelain. Its composition remained a secret until Ehrenfried Walther von Tschirnhaus and Johann Friedrich Böttger successfully produced the first European porcelain in Saxony. Porcelain is baked from a clay consisting chiefly of Kaolin, supplemented by range of other raw materials.



ABOVE: After demolded, FFC washbasins rest for slow drying



BELOW: One-piece toilets lay out for slow drying



RIGHT: Final checkpoint before toilet is sent to fire



ART OF FIRE

Porcelain is made in a kiln with temperatures of over 1200 degrees Celsius.

At these high temperatures, the durability, strength, and translucence of porcelain are formed through Vitrification.



E.FANCY 

Digital Toilet

CA1380H



Tự động xả nước sau khi sử dụng, tự động phân biệt chế độ xả nước ở mức nhiều hay ít

Xả nước mức ít là 4.5 lít

Xả nước mức nhiều là 6 lít



Hệ thống xả áp lực nước cao

Sử dụng phương pháp xả áp lực cao, chỉ sử dụng 1 lượng nước nhỏ là có thể đẩy hết chất dơ vào ống thoát, đạt hiệu quả cao trong việc tiết kiệm nước và bảo vệ môi trường.



Chế tạo ra chức năng vệ sinh có lợi cho tiêu hóa, giúp ích cho bệnh nhân táo bón



E.FANCY

Digital Toilet
CA1380H



CA1380H

Bản cấu điện tử
 Nguồn điện : 220V
 Dung lượng nước : 4.5-6 lít
 Hệ thống xả xoáy kết hợp áp lực cao
 Áp lực nước : 2-7.5 kgf/cm²
 Tầm thoát phân : 300 mm
 720 x 410 x 510 mm



Đặc tính kỹ thuật

Sản phẩm : CA1380H	Nguồn điện/Công suất : 220V, 60HZ / 680-800W	Độ dài dây điện : 1.5m (5 feet)
Thân bản cấu ● Lượng nước xả : Nút lớn : 6lít / Nút nhỏ : 4.5lít ● Cách thức xả nước : xả xoáy kết hợp áp lực cao		
Chức năng rửa sạch ● Lượng nước rửa sau : Lớn nhất : 1.2 lít/phút (áp suất 0.2Mpa) ● Lượng nước rửa trước : Lớn nhất : 1.2 lít/phút		
● Lượng nước rửa hỗ trợ : Lớn nhất : 1.2 lít/phút (áp suất 0.2Mpa) ● Kết nước lắp đặt : 1.2 lít		
● Nhiệt độ nước chảy ra : 34 - 38 - 40 độ C ● Công suất : 600W ● Thiết bị an toàn : 1, 2, 3		1 : Dây tóc nhiệt độ
Nắp ngồi ấm áp ● Nhiệt độ nắp ngồi : 34 - 37 - 40 độ C ● Công suất : 55W ● Thiết bị an toàn : 1, 2		2 : Thiết bị chống nóng
Sấy khô thông gió ● Nhiệt độ gió : 40 - 50 - 59 độ C ● Công suất : 250W ● Thiết bị an toàn : 1, 3		3 : Thiết bị chống cháy
Áp suất nước cấp 2-7.5 kgf/cm ² (0.2-0.75Mpa)	Cấp chống nước IPX4	Nhiệt độ nước cấp : 5-35 độ C
Nhiệt độ môi trường : 5-40 độ C		
Kích thước : 410 x 720 x 510 mm (Rộng x Dài x Cao)		Trọng lượng : 48 kg (Nắp ngồi 8kg + bản cấu 40 kg)

Chỉ dùng nước, không dùng giấy
Thư giãn cùng nắp bàn cầu điện tử Caesar



TAF200H
Nắp bàn cầu điện tử
487x505x154mm



New
TAF400H
Nắp bàn cầu điện tử
443x507x154mm

	Mã số	TAF200H	TAF400H New
Ký Hiệu	Hình ảnh		
	Kích thước	487x505x154	443x507x154
	 Đóng êm	●	●
 Dễ tháo ráp	●	●	
 Tạo bọt khí	●	●	
 Làm sạch Turbo	●	●	
 Nước ấm vệ sinh	●	●	
 Tự động vệ sinh	●	●	
 Điều chỉnh vị trí vòi rửa	●	●	
 Vệ sinh phần trước	●	●	
 Vệ sinh phần sau	●	●	
 Sấy khô	●	-	
 Làm ấm nắp ngồi	●	●	
 Tự làm sạch vòi rửa	●	●	
 Chất liệu vòi rửa	Stainless	Stainless + ABS	
 Có thể thay thế đầu vòi rửa	●	●	
 Bộ lọc nước	Optional	Optional	
 Khử mùi	●	-	
 Tiết kiệm điện	●	●	
 Chế độ an toàn	●	●	

Hướng dẫn lắp đặt
Nâng cấp WC nhà bạn bằng cách
thay nắp bàn cầu điện tử

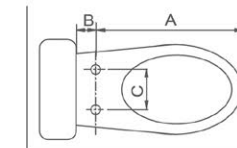

A : 44 ~ 49cm
B : > 4cm
C : 14 ~ 20cm
A + B : > 51cm



CD1363 + TAF200H

easelet

Nắp bàn cầu điện tử siêu sạch

- ★ Hiện đại
- ★ Tiện nghi
- ★ Tiết kiệm
- ★ Thoải mái



TAF200H

Nắp bàn cầu điện tử
487x505x154mm



Áp lực nước : 0.7-5kgf/cm²



easelet

Nắp bồn cầu điện tử siêu sạch
TAF200H

RÕ RÀNG DỄ HIỂU

Ghi chú rõ ràng, dễ hiểu

Đèn chỉ thị phát sáng giúp nhìn rõ hơn



Nhấn 2 lần để kích hoạt chức năng rửa massage

Đầu vòi xịt có 5 mức chỉnh vị trí thích hợp

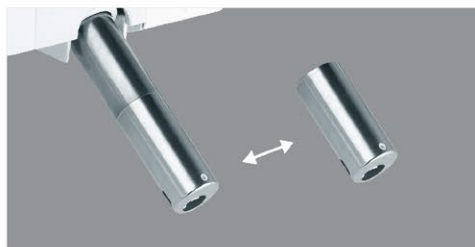

ĐẦU VÒI XỊT BẰNG INOX, THẢO ĐƯỢC



NẶNG CẤP NẶNG BẰNG NHỰA ABS KHÁNG KHUẨN

RỬA BẰNG NƯỚC ẤM

Có 4 mức nhiệt độ điều chỉnh, tận hưởng khoảnh khắc thư giãn



NẶNG NGỒI SƯỞI ẤM

Có 4 mức sưởi điều chỉnh, làm ấm những ngày đông lạnh giá



NẶNG ỀM KHÔNG TIẾNG ỒN



BẢO VỆ AN TOÀN CHUYÊN NGHIỆP



TỰ ĐỘNG LÀM SẠCH ĐẦU VÒI XỊT



CHẾ ĐỘ TIẾT KIỆM ĐIỆN THÔNG MINH



CHỨC NĂNG MASSAGE - SPA



TẠO CẢM GIÁC SẢNG KHOÁI SAU KHI SỬ DỤNG



DỪNG DÒNG NƯỚC BỌT KHÍ AIR-IN



KẾT HỢP LỌC NƯỚC NANO BẠC





CD1356 + TAF200H



**CD1363
TAF200H**

Bàn cầu một khối
 Hệ thống xả hút đặc biệt : 3-4.8 lít
 Nắp bàn cầu điện tử : TAF200H
 Bộ xả thùng nước : FP863A
 Tầm thoát phân : 300 mm
 740 x 400 x 715 mm



**CD1375
TAF200H**

Bàn cầu một khối
 Hệ thống xả Aqua-jet : 3-4.8 lít
 Nắp bàn cầu điện tử : TAF200H
 Bộ xả thùng nước : FP856A
 Tầm thoát phân : 300 mm
 735 x 400 x 735 mm



**CD1348
TAF200H**

Bàn cầu hai khối
 Hệ thống xả đặc biệt : 3-4.8 lít
 Nắp bàn cầu điện tử : TAF200H
 Thùng nước : T1148
 Bộ xả thùng nước : FP840A
 Tầm thoát phân : 300 mm
 725 x 390 x 810 mm



**CD1349
TAF200H**

Bàn cầu hai khối
 Hệ thống xả hút : 3-4.8 lít
 Nắp cơ đa năng : TAF200H
 Thùng nước : T1149
 Bộ xả thùng nước : FP840A
 Tầm thoát phân : 300 mm
 725 x 400 x 745 mm





CD1320 + TAF200H



**CD1345
TAF200H**

Bàn cầu hai khối
 Hệ thống xả thẳng : 3-6 lit
 Nắp bàn cầu điện tử : TAF200H
 Thùng nước : T1145
 Bộ xả thùng nước : FP840A
 Tâm thoát phân : 300 mm
 740 x 390 x 760 mm



**CD1341
TAF200H**

Bàn cầu hai khối
 Hệ thống xả Aqua-jet : 3-4.8 lit
 Nắp bàn cầu điện tử : TAF200H
 Thùng nước : T1241
 Bộ xả thùng nước : FP841A
 Tâm thoát phân : 300 mm
 745 x 385 x 810 mm



**CD1340
TAF200H**

Bàn cầu hai khối
 Hệ thống xả Aqua-jet : 3-4.8 lit
 Nắp bàn cầu điện tử : TAF200H
 Thùng nước : T1140
 Bộ xả thùng nước : FP840B
 Tâm thoát phân : 300 mm
 740 x 390 x 755 mm



**CD1530
TAF200H**

Bàn cầu hai khối
 Hệ thống xả Aqua-jet : 3-4.8 lit
 Nắp bàn cầu điện tử : TAF200H
 Thùng nước : T1130
 Bộ xả thùng nước : FP826A
 Tâm thoát phân : 120-220/300 mm
 Ống thoát phân rời : FP520, FP530
 725 x 390 x 760 mm





- ★ Hiện đại
- ★ Tiện nghi
- ★ Tiết kiệm
- ★ Thoải mái



TAF400H
Nắp bồn cầu điện tử
443 x 507 x 154 mm

Áp lực nước : 0.7-5kgf/cm²

CD1348 + TAF400H



easelet

Nắp bàn cầu điện tử siêu sạch
TAF400H

RÕ RÀNG DỄ HIỂU
Ghi chú rõ ràng, hiển thị dễ hiểu

Rõ ràng dễ hiểu

Đèn chỉ thị phát sáng giúp nhìn rõ hơn

Nhấn 2 lần để kích hoạt chức năng rửa massage

Đầu vòi xịt có 5 mức chỉnh vị trí thích hợp

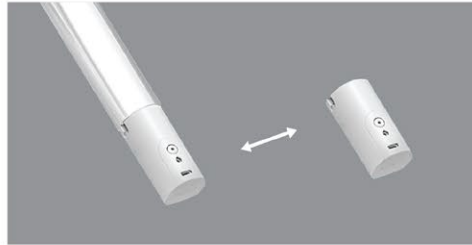

ĐẦU VÒI XỊT BẰNG INOX + NHỰA ABS THÁO ĐƯỢC



NÂNG CẤP NẮP BẰNG NHỰA ABS KHÁNG KHUẨN

RỬA BẰNG NƯỚC ẤM
Có 4 mức nhiệt độ điều chỉnh, tản hướng khoáng khác thứ gian

NẮP NGỒI SƯỜI ẤM
Có 4 mức sưởi điều chỉnh, làm ấm những ngày đông lạnh giá



NẮP ÊM KHÔNG TIẾNG ỒN

BẢO VỆ AN TOÀN CHUYÊN NGHIỆP



TỰ ĐỘNG LÀM SẠCH ĐẦU VÒI XỊT



CHỨC NĂNG MASSAGE - SPA

CHẾ ĐỘ TIẾT KIỆM ĐIỆN THÔNG MINH

Cảm giác sảng khoái sau khi sử dụng

TẠO CẢM GIÁC SẢNG KHOẢI SAU KHI SỬ DỤNG



ĐÒNG NƯỚC BỘT KHÍ AIR-IN

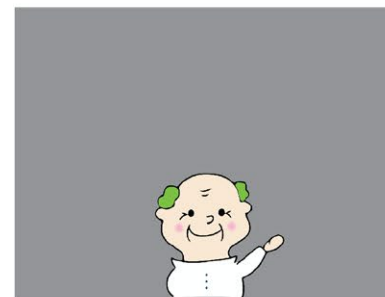

KẾT HỢP LỌC NƯỚC NANO BẠC



CD1356 + TAF400H

Bàn cầu + Nắp điện tử



**CD1363
TAF400H**

Bàn cầu một khối
 Hệ thống xả hút đặc biệt : 3-4.8 lit
 Nắp bàn cầu điện tử : TAF400H
 Bộ xả thùng nước : FP863A
 Tấm thoát phân : 300 mm
 740 x 400 x 715 mm



**CD1375
TAF400H**

Bàn cầu một khối
 Hệ thống xả Aqua-jet : 3-4.8 lit
 Nắp bàn cầu điện tử : TAF400H
 Bộ xả thùng nước : FP856A
 Tấm thoát phân : 300 mm
 735 x 400 x 735 mm



**CD1364
TAF400H**

Bàn cầu một khối
 Hệ thống xả hút : 3-4.8 lit
 Nắp bàn cầu điện tử : TAF400H
 Bộ xả thùng nước : FP864A
 Tấm thoát phân : 300 mm
 690 x 370 x 740 mm



**CD1374
TAF400H**

Bàn cầu một khối
 Hệ thống xả hút : 3-4.8 lit
 Nắp bàn cầu điện tử : TAF400H
 Bộ xả thùng nước : FP874A
 Tấm thoát phân : 300 mm
 690 x 375 x 730 mm



Áp lực nước : 0.7-5kgf/cm²



CD1348 + TAF400H



CD1345
TAF400H

Bàn cầu hai khối
 Hệ thống xả thẳng : 3-6 lít
 Nắp bàn cầu điện tử : TAF400H
 Thùng nước : T1145
 Bộ xả thùng nước : FB840A
 Tâm thoát phân : 300 mm
 740 x 390 x 760 mm



CD1341
TAF400H

Bàn cầu hai khối
 Hệ thống xả Aqua-jet : 3-4.8 lít
 Nắp bàn cầu điện tử : TAF400H
 Thùng nước : T1241
 Bộ xả thùng nước : FB841A
 Tâm thoát phân : 300 mm
 745 x 385 x 810 mm



CD1340
TAF400H

Bàn cầu hai khối
 Hệ thống xả Aqua-jet : 3-4.8 lít
 Nắp bàn cầu điện tử : TAF400H
 Thùng nước : T1140
 Bộ xả thùng nước : FB840B
 Tâm thoát phân : 300 mm
 740 x 390 x 755 mm



CD1320
TAF400H

Bàn cầu hai khối
 Hệ thống xả Aqua-jet : 3-4.8 lít
 Nắp bàn cầu điện tử : TAF400H
 Thùng nước : T1120
 Bộ xả thùng nước : FB826A
 Tâm thoát phân : 300 mm
 730 x 380 x 740 mm



ECO BIDET SEAT

1. NO ELECTRICITY REQUIRED
2. NOZZLE OPERATED BY WATER PRESSURE
3. SIMPLE FUNCTION AND SIMPLE INSTALLATION



TAF050

Front / Rear Cleansing
Adjustable Easy Installation
Working Water Pressure : 0.7 ~ 5 kgf/cm²



Eco Bidet Seat

Nắp bàn cầu cơ đa năng
TAF050

THAO TÁC ĐƠN GIẢN - NHANH CHÓNG



THIẾT KẾ ĐẦU VÒI XỊT
TRƯỚC VÀ SAU RIÊNG BIỆT



VỆ SINH VÒI XỊT
TRƯỚC VÀ SAU KHI SỬ DỤNG

ĐỂ DÀNG THÁO RÁP
CHỈ VỚI 1 NÚT NHẤN



BẢO VỆ AN TOÀN
CHUYÊN NGHIỆP



KHÔNG DÙNG ĐIỆN



NẮP ÊM
KHÔNG TIẾNG ỒN



CD1363 + TAF050



CD1356
TAF050

Bàn cầu một khối
 Hệ thống xả hút : 3-6 lít
 Nắp cơ đa năng : TAF050
 Bộ xả thùng nước : FP856A
 Tâm thoát phân : 300 mm
 725 x 400 x 650 mm



CD1375
TAF050

Bàn cầu một khối
 Hệ thống xả Aqua-jet : 3-4.8 lít
 Nắp cơ đa năng : TAF050
 Bộ xả thùng nước : FP856A
 Tâm thoát phân : 300 mm
 735 x 400 x 735 mm



CD1348
TAF050

Bàn cầu hai khối
 Hệ thống xả đặc biệt : 3-4.8 lít
 Nắp cơ đa năng : TAF050
 Thùng nước : T1148
 Bộ xả thùng nước : FP840A
 Tâm thoát phân : 300 mm
 725 x 390 x 810 mm



CD1349
TAF050

Bàn cầu một khối
 Hệ thống xả hút : 3-4.8 lít
 Nắp cơ đa năng : TAF050
 Thùng nước : T1149
 Bộ xả thùng nước : FP840A
 Tâm thoát phân : 300 mm
 725 x 400 x 745 mm





CD1320 + TAF050



**CD1345
TAF050**

Bàn cầu hai khối
 Hệ thống xả thẳng : 3-6 lít
 Nắp cơ đa năng : TAF050
 Thùng nước : T1145
 Bộ xả thùng nước : FP840A
 Tắm thoát phân : 300 mm
 740 x 390 x 760 mm



**CD1341
TAF050**

Bàn cầu hai khối
 Hệ thống xả Aqua-jet : 3-4.8 lít
 Nắp cơ đa năng : TAF050
 Thùng nước : T1241
 Bộ xả thùng nước : FP841A
 Tắm thoát phân : 300 mm
 745 x 385 x 810 mm



**CD1340
TAF050**

Bàn cầu hai khối
 Hệ thống xả Aqua-jet : 3-4.8 lít
 Nắp cơ đa năng : TAF050
 Thùng nước : T1140
 Bộ xả thùng nước : FP840B
 Tắm thoát phân : 300 mm
 740 x 390 x 755 mm



**CD1530
TAF050**

Bàn cầu hai khối
 Hệ thống xả Aqua-jet : 3-4.8 lít
 Nắp cơ đa năng : TAF050
 Thùng nước : T1130
 Bộ xả thùng nước : FP826A
 Tắm thoát phân : 120-220/300 mm
 Ống thoát phân rời : FP520, FP530
 725 x 390 x 760 mm





C1353



Bàn cầu một khối
Hệ thống xả hút : 6 lit
Nắp êm : MU234
Bộ xả thùng nước : FP853A
Tâm thoát phân : 300 mm
710 x 460 x 640 mm



CD1356



Bàn cầu một khối
Hệ thống xả hút : 3-6 lit
Nắp êm : M256
Bộ xả thùng nước : FP856A
Tâm thoát phân : 300 mm
725 x 400 x 650 mm



New

CD1363



Bàn cầu một khối
 Hệ thống xả hút đặc biệt : 3-4.8 lít
 Nắp êm : M221
 Bộ xả thùng nước : FP863A
 Tâm thoát phân : 300 mm
 740 x 400 x 715 mm



CD1364



Bàn cầu một khối
 Hệ thống xả hút : 3-4.8 lít
 Nắp êm : MU234
 Bộ xả thùng nước : FP864A
 Tâm thoát phân : 300 mm
 690 x 370 x 740 mm



CD1374



Bàn cầu một khối
 Hệ thống xả hút : 3-4.8 lít
 Nắp êm : MU235
 Bộ xả thùng nước : FP874A
 Tâm thoát phân : 300 mm
 690 x 375 x 730 mm



CD1375



Bàn cầu một khối
 Hệ thống xả Aqua-jet : 3-4.8 lít
 Nắp êm : M221
 Bộ xả thùng nước : FP867A
 Tâm thoát phân : 300 mm
 735 x 400 x 735 mm



CD1340



Bàn cầu hai khối
 Hệ thống xả Aqua-jet : 3-4,8 lít
 Nắp êm : M232
 Thùng nước : T1140
 Bộ xả thùng nước : FP840B
 Tấm thoát phân : 300 mm
 740 x 390 x 755 mm



CD1341



Bàn cầu hai khối
 Hệ thống xả Aqua-jet : 3-4,8 lít
 Nắp êm : M232
 Thùng nước : T1241
 Bộ xả thùng nước : FP841A
 Tấm thoát phân : 300 mm
 745 x 385 x 810 mm



CD1345



Bàn cầu hai khối
 Hệ thống xả thẳng : 3-6 lít
 Nắp êm : M232
 Thùng nước : T1145
 Bộ xả thùng nước : FP840A
 Tấm thoát phân : 300 mm
 740 x 390 x 760 mm



CD1346



Bàn cầu hai khối
 Hệ thống xả hút : 3-6 lít
 Nắp êm : M236
 Thùng nước : T1146
 Bộ xả thùng nước : FP840A
 Tấm thoát phân : 300 mm
 720 x 385 x 770 mm



CD1348



Bàn cầu hai khối
 Hệ thống xả đặc biệt : 3-4.5 lít
 Nắp êm : M232
 Thùng nước : T1148
 Bộ xả thùng nước : FP840A
 Tâm thoát phân : 300 mm
 725 x 390 x 810 mm



CD1349



Bàn cầu hai khối
 Hệ thống xả hút : 3-4.5 lít
 Nắp êm : M232
 Thùng nước : T1149
 Bộ xả thùng nước : FP840A
 Tâm thoát phân : 300 mm
 725 x 400 x 745 mm



CD1338
CDS1338



Bàn cầu hai khối
 Hệ thống xả thẳng : 3-6 lít
 Nắp thường / êm : M220 /MS220
 Thùng nước : T1238
 Bộ xả thùng nước : FP825BH
 Tâm thoát ngang : 300 mm
 700 x 375 x 745 mm



CT1338
CTS1338



Bàn cầu hai khối
 Hệ thống xả thẳng : 6 lít
 Nắp thường / êm : M220 /MS220
 Thùng nước : T1138
 Bộ xả thùng nước : FP825AH
 Tâm thoát ngang : 300 mm
 700 x 375 x 745 mm



CD1320



Bồn cầu hai khối
 Hệ thống xả Aqua-jet : 3-4.8 lit
 Nắp êm : M221
 Thùng nước : T1120
 Bộ xả thùng nước : FP826A
 Tắm thoát phần : 300 mm
 730 x 380 x 740 mm



CPT1332



Bồn cầu thoát ngang
 Hệ thống xả thẳng : 6 lit
 Nắp thường : M220
 Thùng nước : T1116
 Bộ xả thùng nước : FP804A
 Tắm thoát ngang : 190 mm
 690 x 370 x 770 mm



B1031



Bệ vệ sinh nữ
 Dùng với vòi B183C
 Tắm thoát ngang : 150mm
 600 x 360 x 360 mm



B183C



Vòi bộ vệ sinh nữ nóng lạnh
 Gồm xả ty xi



C1352



Bàn cầu trẻ em
Hệ thống xả hút : 4.8 lít
Nắp êm : M284
Bộ xả thùng nước : FP855B
Tâm thoát phân : 300 mm
530 x 325 x 585 mm



CT1026



Bàn cầu trẻ em
Hệ thống xả thẳng : 6 lít
Nắp thường : M282
Thùng nước treo : T1127
Bộ xả thùng nước : FP804A
Tâm thoát phân : 360 mm
625 x 295 x 805 mm



Công nghệ xả AQUA JET với thiết kế vành không khe rãnh, để vết bẩn không còn nơi ẩn náu, giúp việc vệ sinh trở nên đơn giản và dễ dàng hơn bao giờ hết. Công nghệ xả cải tiến kết hợp với hệ thống xả 3L/4.8L cực nhanh, cực mạnh vừa làm sạch hiệu quả, vừa tiết kiệm nước tối ưu, thích hợp sử dụng cho nhà vệ sinh gia đình, các công trình và những nơi công cộng. Bàn cầu với kiểu xả thông thường có thiết kế cho dòng nước xả ra từ thành bàn cầu, công nghệ xả AQUA JET với thiết kế vành kín, bàn cầu trông sạch sẽ và đẹp mắt hơn, xả sạch hơn, dễ dàng vệ sinh hơn, hạn chế vi khuẩn và ngăn bám bẩn, giảm thiểu số lần sử dụng chất tẩy rửa để vệ sinh bàn cầu, mang lại nhiều tiện ích cho người sử dụng, đồng thời góp phần bảo vệ môi trường sống.

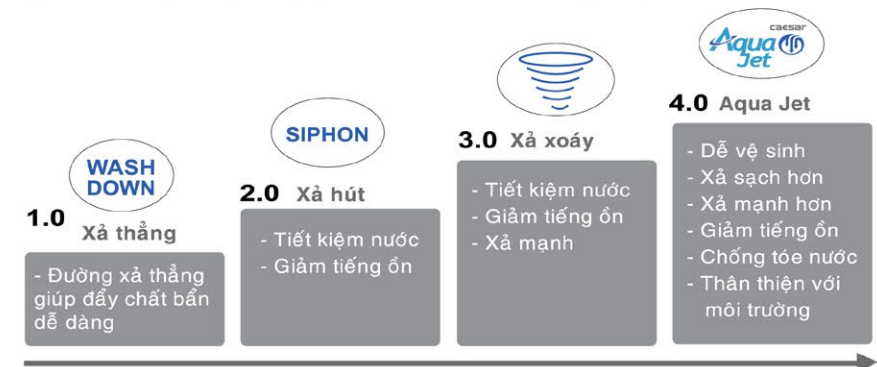

Quá trình phát triển công nghệ xả





CD1375



Bàn cầu một khối
 Hệ thống xả Aqua-jet : 3-4,8 lít
 Nắp êm : M221
 Bộ xả thùng nước : FP856A
 Tâm thoát phân : 300 mm
 735 x 400 x 735 mm



CD1341



Bàn cầu hai khối
 Hệ thống xả Aqua-jet : 3-4,8 lít
 Nắp êm : M232
 Thùng nước : T1241
 Bộ xả thùng nước : FP841A
 Tâm thoát phân : 300 mm
 745 x 385 x 810 mm



CD1320



Bàn cầu hai khối
 Hệ thống xả Aqua-jet : 3-4,8 lít
 Nắp êm : M221
 Thùng nước : T1120
 Bộ xả thùng nước : FP826A
 Tâm thoát phân : 300 mm
 730 x 380 x 740 mm



**CT1325 / CD1325
 CTS1325 / CDS1325**



Bàn cầu hai khối
 Hệ thống xả Aqua-jet : 4,8 lít / 3-4,8 lít
 Nắp thường / êm : M220 / MS220
 Thùng nước : T1125 / T1225
 Bộ xả thùng nước : FP825AH / FP825BH
 Tâm thoát phân : 300 mm
 690 x 370 x 790 mm



CD1530



Bàn cầu hai khối
 Hệ thống xả Aqua-jet : 3-4.8 lit
 Nắp êm : M232
 Thùng nước : T1130
 Bộ xả thùng nước : FP826A
 Tầm thoát phân : 120~220/300 mm
 Ống thoát phân rời : FP520, FP530
 725 x 390 x 760 mm



CD1551



Bàn cầu hai khối
 Hệ thống xả Aqua-jet : 3-4.8 lit
 Nắp êm : MU237
 Thùng nước : T1152
 Bộ xả thùng nước : FP840A
 Tầm thoát phân : 120~220/300 mm
 Ống thoát phân rời : FP500, FP520, FP531
 650 x 370 x 780 mm



Ống Thoát Phân Rời



FP500
 Tầm thoát ngang : 185mm
 Dùng với : CD1551P



FP530
 Tầm thoát : 300mm
 Dùng với : CD1530N



FP520
 Tầm thoát : 120 ~220mm
 Dùng với : CD1530U / CD1551U



FP531
 Tầm thoát : 300mm
 Dùng với : CD1551N



FP500



FP530



FP520



FP531

Lưu ý : CD1530 và CD1551 chỉ thích hợp với đường kính ống thoát phân ≥ 110 mm



Bàn cầu thùng nước âm tường



TH1510
Thùng nước âm tường



CPT1503



Bàn cầu thùng nước âm tường
Hệ thống xả thẳng : 3-6 lít
Nắp êm : M243
Thùng nước âm : TH1510
Tâm thoát phân ngang : 220 mm
530 x 350 x 355 mm



CT1250

Bàn cầu xổm
 Dung lượng nước : 3-6 lít
 Thùng nước treo : T1113
 Bộ xả thùng nước : FPL813A
 Tâm thoát phân : 655 mm
 645 x 295 x 445 mm



CS1230

Bàn cầu xổm
 Dung lượng nước : 6 lít
 Thùng nước treo : T1100
 Bộ xả thùng nước : FP807A
 Tâm thoát phân : 695 mm
 595 x 300 x 460 mm



CS1280

Bàn cầu xổm
 Dung lượng nước : 6 lít
 Thùng nước treo : T1100
 Bộ xả thùng nước : FP807A
 Tâm thoát phân : 795 mm
 710 x 290 x 470 mm



Chú ý : Ký hiệu mã số bàn cầu trên catalogue có khác biệt so với khi giao hàng ví dụ như sau :

Catalogue	Giao hàng
Bàn cầu hai khối	
CD1340 màu trắng	C1340A-PW + T1140APW
CT1325 màu trắng	C1325A-PW + T1125A-PW
Bàn cầu một khối	
CD1375 màu trắng	C1375C-PW

Chú ý :

- BF443 / BF446 / BF449 :
- Áp lực nước : 1~4 kgf/cm²
- Đường kính ống cấp : 34 mm



C1230 + BF449

Bàn cầu xổm
 Dung lượng nước : 6 lít
 Dừng với bộ xả : BF449
 Áp lực nước : 1~4kgf/cm²
 Tâm thoát phân : 695 mm
 595 x 300 x 460 mm



C1250 + BF446

Bàn cầu xổm
 Dung lượng nước : 6 lít
 Dừng với bộ xả : BF446
 Áp lực nước : 1~4kgf/cm²
 Tâm thoát phân : 695 mm
 645 x 295 x 445 mm



CP1333 + BF443

Bàn cầu xả gạt tay
 Hệ thống xả thẳng : 6 lít
 Nắp thường : M220
 Dừng với bộ xả : BF443
 Áp lực nước : 1~4kgf/cm²
 Tâm thoát phân : 300 mm
 660 x 375 x 370 mm

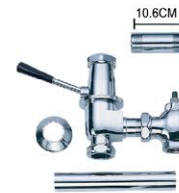

BF443 Bộ xả bàn cầu

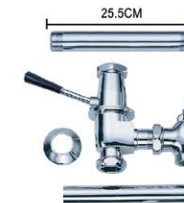

BF446 Bộ xả bàn cầu



BF449 Bộ xả bàn cầu



FFC
FINE FIRE CLAY



Các kiểu kết hợp lavabô và tủ treo :



Lavabô (Lavender)



EH43000EW
Tủ treo
418 x 300 x 400 mm



EH44000AW
Tủ treo
435 x 400 x 400 mm

1 Thiết kế đảm bảo ĐẸP

EM0145W
Tủ Gương
170x450x640mm



Lavabô (Lavender)



L5261



- o Lavabô treo tường / Đặt trên bàn
450 x 420 x 110 mm



New

L5261
EH05261A



- o Lavabô treo tường / Đặt trên bàn
450 x 420 x 110 mm
- o Tủ lavabô treo
435 x 410 x 400 mm



New

L5261
EH05261AW



- o Lavabô treo tường / Đặt trên bàn
450 x 420 x 110 mm
- o Tủ lavabô treo
435 x 410 x 400 mm



New

L5261
EH05261ATG



- o Lavabô treo tường / Đặt trên bàn
450 x 420 x 110 mm
- o Tủ lavabô treo
435 x 410 x 400 mm

2 Chất liệu đảm bảo BỀN



Lavabô (Lavender)



LF5253



- o Lavabô treo tường / Đặt trên bàn
450 x 500 x 115 mm



LF5253

EH05253A



- o Lavabô treo tường / Đặt trên bàn
450 x 500 x 115 mm
- o Tủ lavabô treo
435 x 490 x 400 mm



LF5253

EH05253AW



- o Lavabô treo tường / Đặt trên bàn
450 x 500 x 115 mm
- o Tủ lavabô treo
435 x 490 x 400 mm



LF5253

EH05253ATG



- o Lavabô treo tường / Đặt trên bàn
450 x 500 x 115 mm
- o Tủ lavabô treo
435 x 490 x 400 mm

3

Chất lượng đảm bảo **TỐT**



Lavabô (Lavender)

LF5259



- o Lavabô treo tường / Đặt trên bàn
380 x 500 x 115 mm



LF5259

EH05259A



- o Lavabô treo tường / Đặt trên bàn
380 x 500 x 115 mm
- o Tủ lavabô treo
365 x 485 x 400 mm



LF5259

EH05259AW



- o Lavabô treo tường / Đặt trên bàn
380 x 500 x 115 mm
- o Tủ lavabô treo
365 x 485 x 400 mm



LF5259

EH05259ATG



- o Lavabô treo tường / Đặt trên bàn
380 x 500 x 115 mm
- o Tủ lavabô treo
365 x 485 x 400 mm



4 Lavabô + tủ đảm bảo CHẤT



Lavabô (Lavender)



LF5255



- o Lavabô treo tường / Đặt trên bàn
450 x 450 x 115 mm



LF5255

EH05255A



- o Lavabô treo tường / Đặt trên bàn
450 x 450 x 115 mm
- o Tủ lavabô treo
435 x 435 x 400 mm



LF5255

EH05255AW



- o Lavabô treo tường / Đặt trên bàn
450 x 450 x 115 mm
- o Tủ lavabô treo
435 x 435 x 400 mm



LF5255

EH05255ATG



- o Lavabô treo tường / Đặt trên bàn
450 x 450 x 115 mm
- o Tủ lavabô treo
435 x 435 x 400 mm

5

Sử dụng đảm bảo AN TOÀN



Lavabô (Lavender)



LF5257



- o Lavabô treo tường / Đặt trên bàn
400 x 400 x 115 mm

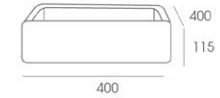

LF5257

EH05257A



- o Lavabô treo tường / Đặt trên bàn
400 x 400 x 115 mm
- o Tủ lavabô treo
385 x 390 x 400 mm



LF5257

EH05257AW



- o Lavabô treo tường / Đặt trên bàn
400 x 400 x 115 mm
- o Tủ lavabô treo
385 x 390 x 400 mm



LF5257

EH05257ATG



- o Lavabô treo tường / Đặt trên bàn
400 x 400 x 115 mm
- o Tủ lavabô treo
385 x 390 x 400 mm



LF5382



LF5384

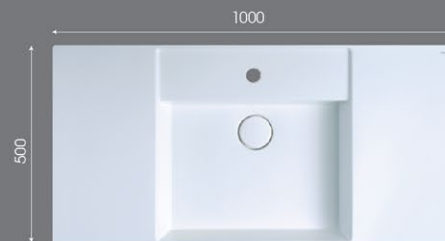

LF5386

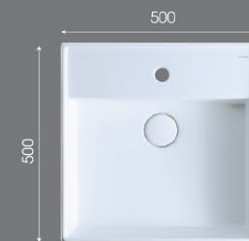

LF5380

Lavabô (Hyacinths)

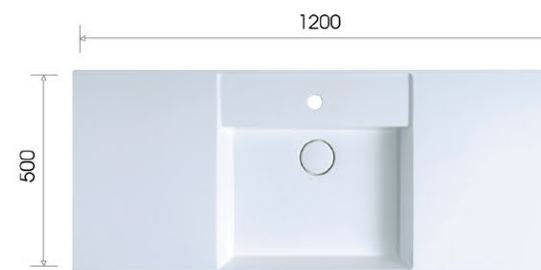

LF5388

Style x Space

Caesar cabinet helps you give all your things a place of their own





Push Open Cabinet

Handless convenience with revolutionary mechanical solution



Full trigger range opens anywhere you like with just a light push



Full-extension synchronized design gives you a reliable smooth-running drawer

Lavabõ (Hyacinths)



LF5380
EH05380DW



- o Lavabõ treo tường / Đặt trên bàn
500 x 500 x 100 mm
- o Tủ lavabõ treo
480 x 490 x 450 mm



LF5382
EH05382DW



- o Lavabõ treo tường / Đặt trên bàn
500 x 800 x 100 mm
- o Tủ lavabõ treo
480 x 790 x 500 mm



LF5384
EH05382DW



- o Lavabõ treo tường / Đặt trên bàn
500 x 800 x 100 mm
- o Tủ lavabõ treo
480 x 790 x 500 mm



LF5386
EH05386DW



- o Lavabõ treo tường / Đặt trên bàn
500 x 1000 x 100 mm
- o Tủ lavabõ treo
480 x 990 x 500 mm



LF5388
EH05388DW



- o Lavabõ treo tường / Đặt trên bàn
500 x 1200 x 100 mm
- o Tủ lavabõ treo
480 x 1190 x 500 mm



Lavabô (Hyacinths)



LF5380
EH05380A



- Lavabô treo tường / Đặt trên bàn
500x500x100mm
- Tủ lavabô treo
480x490x450mm



LF5382
EH05382A



- Lavabô treo tường / Đặt trên bàn
500 x 800 x 100 mm
- Tủ lavabô treo
480 x 785 x 450 mm



LF5384
EH05382A



- Lavabô treo tường / Đặt trên bàn
500 x 800 x 100 mm
- Tủ lavabô treo
480 x 785 x 450 mm



LF5386
EH05386A



- Lavabô treo tường / Đặt trên bàn
500 x 1000 x 100 mm
- Tủ lavabô treo
480 x 990 x 450 mm



LF5388
EH05388A



- Lavabô treo tường / Đặt trên bàn
500 x 1200 x 100 mm
- Tủ lavabô treo
480 x 1190 x 450 mm



Lavabô (Jasmine)





LF5370
EH05370A



- o Lavabô treo tường
500 x 550 x 80 mm
- o Tũ lavabô treo
430 x 415 x 350 mm



LF5372
EH05372A



- o Lavabô treo tường
500 x 750 x 80 mm
- o Tũ lavabô treo
440 x 685 x 350 mm



LF5374
EH05374A



- o Lavabô treo tường
500 x 750 x 80 mm
- o Tũ lavabô treo
440 x 685 x 350 mm



LF5376
EH05376A



- o Lavabô treo tường
500 x 900 x 80 mm
- o Tũ lavabô treo
440 x 775 x 350 mm

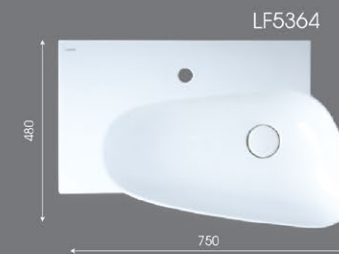

Lavabô (Begonia)



LF5260



- o Lavabô trên bàn
340 x 640 x 100 mm



LF5036
EH05036AV



- Lavabô bàn
500 x 800 x 200 mm
- Tủ lavabô treo
490 x 780 x 640 mm



LF5368
EH05368AD



- Lavabô bàn
500 x 900 x 145 mm
- Tủ lavabô treo
483 x 865 x 450 mm



LF5362
EH05362AD



- Lavabô treo tường
480 x 750 x 100 mm
- Tủ lavabô treo
380 x 625 x 450 mm



LF5364
EH05364AD



- Lavabô treo tường
480 x 750 x 100 mm
- Tủ lavabô treo
380 x 625 x 450 mm



Lavabô (Wisteria)





LF5028
EH05028DDV



- o Lavabô bân
500x1000x210mm
- o Tủ lavabô treo - Hộc kéo
480x985x350mm



LF5024
EH05024DDV



- o Lavabô bân
500 x 600 x 210 mm
- o Tủ lavabô treo - Hộc kéo
480 x 580 x 350 mm



LF5026
EH05026DDV



- o Lavabô bân
500 x 800 x 210 mm
- o Tủ lavabô treo - Hộc kéo
480 x 780 x 350 mm



LF5030
EH05030DDV



- o Lavabô bân
500 x 650 x 180 mm
- o Tủ lavabô treo - Hộc kéo
480 x 630 x 350 mm



LF5032
EH05032DDV



- o Lavabô bân
500 x 750 x 180 mm
- o Tủ lavabô treo - Hộc kéo
480 x 730 x 350 mm



LF5324
EH05324AV



- Lavabô treo
530 x 1205 x 205 mm
- Tũ lavabô treo
365 x 1160 x 600 mm



LF5236
EH05236AV



- Lavabô treo
480 x 505 x 175 mm
- Tũ lavabô treo
468 x 495 x 485 mm



LF5302
EH05302AV



- Lavabô treo
550 x 490 x 200 mm
- Tũ lavabô treo
315 x 480 x 640 mm



LF5017
EH05017AV



- Lavabô bàn
480 x 605 x 180 mm
- Tũ lavabô treo
470 x 590 x 640 mm



LF5038
EH05038AV



- Lavabô bán
550 x 600 x 135mm
- Tủ lavabô treo
540 x 580 x 640 mm



LF5024
EH05024AV



- Lavabô bán
500 x 600 x 210 mm
- Tủ lavabô treo
490 x 575 x 635 mm



LF5239S
EH05239AV



- Lavabô treo
250 x 500 x 130 mm
- Tủ lavabô treo
250 x 492 x 525 mm



EH-14

Chân tủ lavabô
140-160mm

TThích hợp với: EH46001A, EH46002A,
EH05302AV, EH05024AV, EH05236AV,
EH05239AV, EH05038AV, EH05017AV,
EH05036AV, EH05324AV





LF5252

◦ Lavabô trên bàn
400 x 400 x 100 mm



LF5254

◦ Lavabô trên bàn
350 x 500 x 100 mm



LF5258

◦ Lavabô trên bàn
420 x 420 x 100 mm



New
L5221

◦ Lavabô trên bàn
420 x 420 x 120 mm



LF5232

◦ Lavabô trên bàn
375 x 375 x 150 mm



LF5239S

◦ Lavabô trên bàn
250 x 500 x 130 mm





LF5256



◦ Lavabô trên bàn
400 x 400 x 130 mm



LF5260



◦ Lavabô trên bàn
340 x 640 x 100 mm



L5215



◦ Lavabô trên bàn
425 x 425 x 145 mm



L5222



◦ Lavabô trên bàn
460 x 460 x 185 mm



LF5236



◦ Lavabô trên bàn / Treo
480 x 505 x 175 mm



LF5240



◦ Lavabô trên bàn
470 x 470 x 175 mm



LF5236
EH46001A



- Lavabô trên bàn
480 x 505 x 175 mm
- Tủ lavabô treo
500 x 600 x 560 mm



LF5240
EH46001A



- Lavabô trên bàn
470 x 470 x 175 mm
- Tủ lavabô treo
500 x 600 x 560 mm



L5261
EH46001A



- Lavabô trên bàn
450 x 420 x 110 mm
- Tủ lavabô treo
500 x 600 x 560 mm



LF5255
EH46001A



- Lavabô trên bàn
450 x 450 x 115 mm
- Tủ lavabô treo
500 x 600 x 560 mm



LF5253
EH46001A



- Lavabô trên bàn
450 x 500 x 115 mm
- Tủ lavabô treo
500 x 600 x 560 mm



LF5259
EH46001A



- Lavabô trên bàn
380 x 500 x 115 mm
- Tủ lavabô treo
500 x 600 x 560 mm



LF5252
EH46002A



- o Lavabô trên bàn
400 x 400 x 100 mm
- o Tủ lavabô treo
500 x 600 x 560 mm



LF5258
EH46002A



- o Lavabô trên bàn
420 x 420 x 100 mm
- o Tủ lavabô treo
500 x 600 x 560 mm



LF5254
EH46002A



- o Lavabô trên bàn
350 x 500 x 100 mm
- o Tủ lavabô treo
500 x 600 x 560 mm



L5221
EH46002A



- o Lavabô trên bàn
420 x 420 x 120 mm
- o Tủ lavabô treo
500 x 600 x 560 mm



L5215
EH46002A



- Lavabô trên bàn
425 x 425 x 145 mm
- Tủ lavabô treo
500 x 600 x 560 mm



L5222
EH46002A



- Lavabô trên bàn
460 x 460 x 185 mm
- Tủ lavabô treo
500 x 600 x 560 mm



LF5232
EH46002A



- Lavabô trên bàn
375 x 375 x 150 mm
- Tủ lavabô treo
500 x 600 x 560 mm



LF5256
EH46002A



- Lavabô trên bàn
400 x 400 x 130 mm
- Tủ lavabô treo
500 x 600 x 560 mm



LF5018



◦ Lavabô dương bàn
450 x 520 x 215 mm



LF5016



◦ Lavabô dương bàn
450 x 450 x 165 mm



LF5017



◦ Lavabô dương bàn
480 x 605 x 180 mm



LF5038



◦ Lavabô dương bàn
550 x 600 x 135 mm



LF5302



◦ Lavabô dương bàn
555 x 490 x 200 mm



L5125



◦ Lavabô âm bàn
400 x 525 x 185 mm



LF5127



◦ Lavabô âm bàn
435 x 435 x 170 mm



LF5118



◦ Lavabô âm bàn
450 x 450 x 165 mm



LF5128



◦ Lavabô âm bàn
450 x 450 x 165 mm



L5115



◦ Lavabô âm bàn
380 x 460 x 185 mm



L5113



◦ Lavabô âm bàn
390 x 530 x 195 mm



LF5130



◦ Lavabô âm bàn
390 x 665 x 165 mm



(Chất liệu Inox)

BF442-5

Phần đỡ lavabô âm bàn
350 x 20 x 160 mm
(Thích hợp với tất cả lavabô
âm bàn Caesar)



L2140    

◦ Lavabô treo
405 x 405 x 185 mm



LF5239S     

◦ Lavabô treo
250 x 500 x 130 mm



New

L2152
P2443    

◦ Lavabô treo : 450 x 500 x 185 mm
◦ Chân treo



L2220
P2436    

◦ Lavabô treo : 460 x 550 x 200 mm
◦ Chân treo



L2014   

◦ Lavabô treo góc
360 x 360 x 145 mm



LF5238    

◦ Lavabô treo góc
410 x 410 x 165 mm



New

L2365
P2443   

◦ Lavabô treo : 480 x 600 x 185 mm
◦ Chân treo



LF2270
PF2470    

◦ Lavabô treo : 545 x 710 x 210 mm
◦ Chân treo



Lavabô treo



L2140
P2440



- Lavabô treo : 405 x 405 x 185 mm
- Chân đứng



L2140
P2445



- Lavabô treo : 405 x 405 x 185 mm
- Chân đứng



New
L2152
P2445



- Lavabô treo : 450 x 500 x 185 mm
- Chân đứng



L2220
P2437



- Lavabô treo : 460 x 550 x 200 mm
- Chân đứng



New
L2365
P2445



- Lavabô treo : 480 x 600 x 185 mm
- Chân đứng

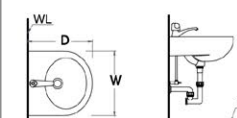

Kích thước : D x W x H mm

Ghi chú :

D : Khoảng cách từ tường ra mép sản phẩm
W : Khoảng cách ngang (song song với tường)
H : Chiều cao sản phẩm

PUBLIC - URINAL

ALL-PURPOSE

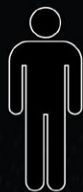

Cảm ứng phức hợp thông minh - tiến vào thời đại cảm ứng mới

Cảm ứng xả chính xác, không sai sót

Công nghệ ứng dụng môi từ nước ngoài, cảm ứng thực hiện xả nước ổn định.

Cảm ứng thông minh vị trí dung dịch, tránh nước bắn tràn ra ngoài

Khi có chất bẩn làm tắc nghẽn, cảm ứng đo được vị trí nước dâng cao sẽ ngưng xả nước, tránh nước bắn tràn ra ngoài.

Chế độ tần suất sử dụng, điều chỉnh lượng nước

Chế độ thông minh, tiết kiệm nước 30%

> Liên tục 3 người trở lên sử dụng, hệ thống sẽ bật chế độ tần suất cao

> Trong chế độ tần suất cao, sẽ xả với lượng nước ít hơn

> Sau khi hủy bỏ chế độ tần suất cao (sau 1.5-2 phút), sẽ xả nước mạnh để làm sạch



Thiết bị xả kết hợp đèn LED

Thiết bị cảm ứng lắp đặt bên trong phần sứ, đơn giản, sạch đẹp.



Khi ở chế độ tần suất thấp, xả nước về sinh bình thường, đảm bảo bộ tiểu sạch sẽ.



Khi ở chế độ tần suất cao, lượng nước xả ít hơn, rút ngắn thời gian chờ, sau khi hủy bỏ chế độ tần suất cao, tiến hành xả nước mạnh để làm sạch.



New

UA0234



- o Bộ tiểu treo
410 x 370 x 630 mm
- o Xả tiểu cảm ứng
(A655B-RA)



New

UA0237



- o Bộ tiểu treo
420 x 400 x 900 mm
- o Xả tiểu cảm ứng
(A655B-RA)



U0232
A654



- Bệ tiểu treo
- 410 x 370 x 630 mm
- Xả tiểu cảm ứng



U0235
A654



- Bệ tiểu treo
- 420 x 400 x 900 mm
- Xả tiểu cảm ứng



U0239
A654



- Bệ tiểu đứng
- Thoát xuống sàn
- 410 x 400 x 1000 mm
- Xả tiểu cảm ứng

MAGIC POWER

HYDROPOWER TECHNOLOGY

Sản phẩm cảm ứng tự tạo nguồn điện Caesar
Không cần dây điện, không phích cắm

Sử dụng



Sử dụng xong



Không sử dụng

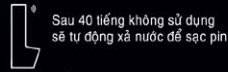

Magic Power



**UMP0283
A670**



- Bộ tiểu treo
400 x 370 x 860 mm
- Xà tiểu cảm ứng



**UMP0284
A670**



- Bộ tiểu đứng
Thoát xuống sàn
400 x 375 x 1000 mm
- Xà tiểu cảm ứng

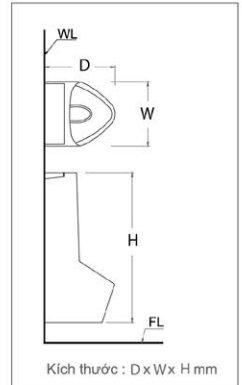

Kích thước : D x W x H mm

Ghi chú :

- D** : Khoảng cách từ tường ra mép sản phẩm
- W** : Khoảng cách ngang (song song với tường)
- H** : Chiều cao sản phẩm



**U0282
A671**



- Bộ tiểu treo
400 x 375 x 755 mm
- Xà tiểu cảm ứng
7 x 120 x 120 mm



**U0282
A672**



- Bộ tiểu treo
400 x 375 x 755 mm
- Xà tiểu cảm ứng
7 x 220 x 120 mm



**U0296
A673**



- Bộ tiểu đứng
Thoát xuống sàn
380 x 320 x 860 mm
- Xà tiểu cảm ứng
118 x 220 x 120 mm





**UA0282
A654**



- Bệ tiểu treo
400 x 375 x 755 mm
- Xả tiểu cảm ứng



**UA0283
A640**



- Bệ tiểu treo
400 x 370 x 860 mm
- Xả tiểu cảm ứng



**UA0284
A640**



- Bệ tiểu đứng
Thoát xuống sàn
400 x 375 x 1000 mm
- Xả tiểu cảm ứng



**UA0296
A648**



- Bệ tiểu đứng
Thoát xuống sàn
380 x 320 x 860 mm
- Xả tiểu cảm ứng



U0264
A637



- Bệ tiểu treo
- 300 x 285 x 660 mm
- Xả tiểu cảm ứng



U0267
A637



- Bệ tiểu treo
- 340 x 305 x 660 mm
- Xả tiểu cảm ứng



U0266
A654



- Bệ tiểu treo
- 325 x 315 x 870 mm
- Xả tiểu cảm ứng



**U0210
BF410**



- o Bộ tiểu treo
240 x 310 x 330 mm
- o Xả tiểu nhấn



**U0221
BF412G**



- o Bộ tiểu treo
240 x 290 x 535 mm
- o Xả tiểu nhấn



**U0230
A657DC-PW**



- o Bộ tiểu treo
270 x 335 x 555 mm
- o Xả tiểu cảm ứng



**U0240
A623**



- o Bộ tiểu treo
310 x 400 x 625 mm
- o Xả tiểu cảm ứng



**U0261
A637**



- o Bộ tiểu treo
360 x 310 x 545 mm
- o Xả tiểu cảm ứng



**U0233
A637
A610OZ**



- o Bộ tiểu treo
410 x 335 x 520 mm
- o Xả tiểu cảm ứng
- o Máy tạo Ozon



SS558AS

- Chậu giết
Thoát xuống sàn
425 x 530 x 660 mm



SS558AP

- Chậu giết
Thoát ngang
425 x 530 x 710 mm



UW0320

- Vách ngăn bệ tiểu treo
390 x 85 x 830 mm



UW0330

- Vách ngăn bệ tiểu treo
390 x 85 x 815 mm



A624

- o Xả tiêu cảm ứng
- Dùng điện 220V
- 100 x 95 x 185 mm



New

A656

- o Xả tiêu cảm ứng
- Dùng điện 220V
- 76 x 101 x 194 mm



A623

- o Xả tiêu cảm ứng
- Dùng điện 220V
- 110 x 250 x 140 mm



A652DC-PW

- o Xả tiêu cảm ứng
- Dùng pin : 3V (2 pin 1.5V)
- 110 x 65 x 135 mm



New

A657DC-PW

- o Xả tiêu cảm ứng
- Dùng pin : 3V (2 pin 1.5V)
- 76 x 128 x 138 mm



A648

- o Xả tiêu cảm ứng
- Dùng điện 220V
- 140 x 260 x 110 mm



A637

- o Xả tiêu cảm ứng âm tường
- Dùng điện 220V
- 7 x 120 x 120 mm



A654

- o Xả tiêu cảm ứng âm tường
- Dùng điện 220V
- 7 x 120 x 120 mm



New

A649OZ

- o Xả tiêu cảm ứng tạo Ozon
- Dùng điện 220V
- 88 x 242 x 110 mm



A671

- o Xả tiêu cảm ứng âm tường
- Không dùng điện
- 7 x 120 x 120 mm



A672

- o Xả tiêu cảm ứng âm tường
- Không dùng điện
- 7 x 220 x 120 mm



A673

- o Xả tiêu cảm ứng
- Không dùng điện
- 118 x 220 x 120 mm



A610

- o Máy sấy tay
- Dùng điện 220V -1800W
- 170 x 245 x 220 mm



A801

- o Máy sấy tay
- Dùng điện 220V -1400W
- 165 x 250 x 245 mm



New

A803

- o Máy sấy tay
- Dùng điện 220V -1650W
- 165 x 250 x 470 mm



New

A610OZ

- o Máy tạo Ozon
- Dùng điện 220V
- 130 x 56 x 130 mm



BF412G

- o Xả tiêu ấn tay



BF410

- o Xả tiêu ấn tay

Auto flushing



A910

Vòi cảm ứng lavabo
Dùng điện AC220V
Bao gồm bộ xả nhấn
H = 112, H1 = 75, L = 102



A911

Vòi cảm ứng lavabo
Dùng điện AC 220V / DC 6V
Bao gồm bộ xả nhấn
H = 130, H1 = 84, L = 125



A912

Vòi cảm ứng lavabo
Dùng điện AC 220V / DC 6V
Bao gồm bộ xả nhấn
H = 137, H1 = 105, L = 100



New Wave,
New Life Style.



S578C

143

Sen thuyền



SP132

Sen thuyền nóng lạnh
Tay sen 01 chế độ
505 x 290 x 1745 mm

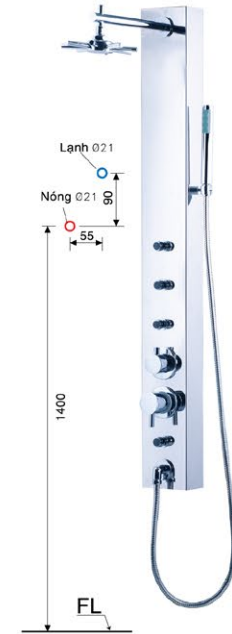

SP137

Sen thuyền nóng lạnh
Tay sen 01 chế độ
480 x 220 x 1220 mm



SP149

Sen thuyền nóng lạnh
Tay sen 01 chế độ
335 x 280 x 1645 mm

Tất cả Sen thuyền, Sen tắm đứng : Áp lực nước cấp 2~5 kg/cm²

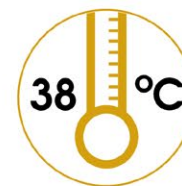

Công nghệ mới giúp duy trì **nhật độ nước ổn định** mặc dù nhiệt độ và áp lực nước cấp thay đổi do nước đang sử dụng ở nơi khác trong nhà, nhờ vậy bạn có thể tin tưởng vào **nhật độ nước**, cho dù bạn đang ở trong phòng tắm hoặc đang rửa tay mà **không cần phải điều chỉnh một cách thủ công**.





Sen Tắm Nhiệt Tự Động

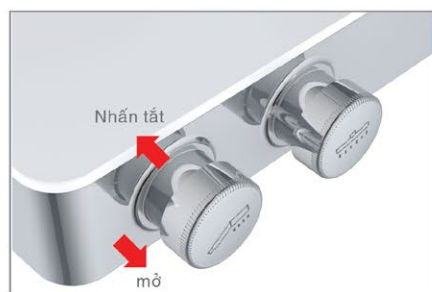
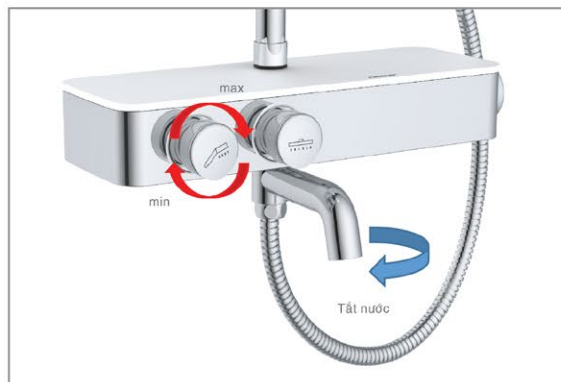

New



TS617

Sen nhiệt tự động

Tay sen 03 chế độ



New



S788C

Sen tắm đứng nhiệt tự động

Tay sen 03 chế độ

H = 935 - 1135 mm





BS641

Sen tắm đứng âm tường



BS641

Sen âm tường nóng lạnh
Không bao gồm ống âm tường
Tay sen 01 chế độ



BS644

Sen âm tường nóng lạnh
Không bao gồm ống âm tường





S668C



S668C

Sen tắm đứng nóng lạnh
Tay sen 01 chế độ
H = 950 ~ 1330 mm



S488C

Sen tắm đứng nóng lạnh
Tay sen 03 chế độ
H = 1000 ~ 1300 mm



S648C

Sen tắm đứng nóng lạnh
Tay sen 01 chế độ
H = 1100 mm



S1028S



S1028S
Sen tắm đứng nóng lạnh
Tay sen 03 chế độ
H = 974 ~ 1324 mm



S378C
Sen tắm đứng nóng lạnh
Tay sen 03 chế độ
H = 820 ~ 1300 mm



S578C
Sen tắm đứng nóng lạnh
Tay sen 03 chế độ
H = 955 ~ 1245 mm



TS617 + BS126



BS122

Phụ kiện sen tắm đứng
H = 1100 mm
H1 = 600 mm



BS125

Phụ kiện sen tắm đứng
H = 950 mm
H1 = 700 mm

New



BS126

Phụ kiện sen tắm đứng
H = 1167 mm
H1 = 820 mm

BS124

Phụ kiện sen tắm đứng
H = 950 mm
H1 = 700 mm



S488C



S383C + BS122

Sen nóng lạnh kết hợp
bộ phụ kiện sen tắm đứng
Tay sen 01 chế độ



S123C + BS125

Sen nóng lạnh kết hợp
bộ phụ kiện sen tắm đứng
Tay sen 01 chế độ



S493C + BS124

Sen nóng lạnh kết hợp
bộ phụ kiện sen tắm đứng
Tay sen 01 chế độ

New

S360C + BS126

Sen nóng lạnh kết hợp
bộ phụ kiện sen tắm đứng
Tay sen 01 chế độ





B810CU Bộ xả nhấn

Vòi lavabo nóng lạnh
H = 162, H1 = 115, L = 113



S813C

Sen nóng lạnh
Tay sen 01 chế độ





B820CU Bộ xả nhấn

Vòi lavabo nóng lạnh
H = 168, H1 = 117, L = 130



S823C

Sen nóng lạnh
Tay sen 03 chế độ





B840CU Bộ xả nhấn

Vòi lavabo nóng lạnh
H = 188, H1 = 135, L = 121



S843C

Sen nóng lạnh
Tay sen 03 chế độ





B550CU Bộ xả nhấn

Vòi lavabo nóng lạnh
H = 188, H1 = 114, L = 117



S553C

Sen nóng lạnh
Tay sen 03 chế độ





B420CU Bộ xả nhấn 

Vòi lavabo nóng lạnh
H = 198, H1 = 105, L = 109



S423C 

Sen nóng lạnh
Tay sen 01 chế độ





B120CP Bộ xả ty
B120CU Bộ xả nhấn
 Vòi lavabo nóng lạnh
 H = 102, H1 = 41, L = 97



B380CP Bộ xả ty
B380CU Bộ xả nhấn
 Vòi lavabo nóng lạnh
 H = 118, H1 = 61, L = 101



B122CP Bộ xả ty
B122CU Bộ xả nhấn
 Vòi lavabo nóng lạnh
 H = 102, H1 = 41, L = 97



B382CP Bộ xả ty
B382CU Bộ xả nhấn
 Vòi lavabo nóng lạnh
 H = 118, H1 = 61, L = 101



S123C
 Sen nóng lạnh
 Tay sen xi, 01 chế độ



S383C
S383CP
 Sen nóng lạnh
 Tay sen xi, 01 chế độ
 Tay sen trắng, 01 chế độ



B260CP Bộ xả ty
B260CU Bộ xả nhấn
Vòi lavabo nóng lạnh
H = 140, H1 = 45, L = 120



B262CP Bộ xả ty
B262CU Bộ xả nhấn
Vòi lavabo nóng lạnh
H = 122, H1 = 45, L = 115



S360CP
Sen nóng lạnh
Tay sen trắng, 01 chế độ



S360C
Sen nóng lạnh
Tay sen xi, 01 chế độ



B490CP Bộ xả ty
B490CU Bộ xả nhấn
 Vòi lavabô nóng lạnh
 H = 138, H1 = 60, L = 106



B560CP Bộ xả ty
B560CU Bộ xả nhấn
 Vòi lavabô nóng lạnh
 H = 134, H1 = 61, L = 109



B492CP Bộ xả ty
B492CU Bộ xả nhấn
 Vòi lavabô nóng lạnh
 H = 120, H1 = 55, L = 107



B562CP Bộ xả ty
B562CU Bộ xả nhấn
 Vòi lavabô nóng lạnh
 H = 127, H1 = 54, L = 109



S493C
 Sen nóng lạnh
 Tay sen xi, 01 chế độ



S563C
 Sen nóng lạnh
 Tay sen 03 chế độ



B400CP Bộ xả ty
B400CU Bộ xả nhấn

Vòi lavabô nóng lạnh
H = 137, H1 = 58, L = 119



B430CP Bộ xả ty
B430CU Bộ xả nhấn

Vòi lavabô nóng lạnh
H = 138, H1 = 60, L = 112



B402CP Bộ xả ty
B402CU Bộ xả nhấn

Vòi lavabô nóng lạnh
H = 129, H1 = 49, L = 116



B432CP Bộ xả ty
B432CU Bộ xả nhấn

Vòi lavabô nóng lạnh
H = 130, H1 = 52, L = 112



S403C

Sen nóng lạnh
Tay sen 01 chế độ



S433C

Sen nóng lạnh
Tay sen 03 chế độ



B308C (âm tường)
Vòi lavabo nóng lạnh
L = 242



TS617
Sen nhiệt tự động
Tay sen 03 chế độ



B350CU Bộ xả nhấn
Vòi lavabo nóng lạnh
H = 145, H1 = 59, L = 108



S353C
Sen nóng lạnh
Tay sen 03 chế độ



New
B390CU Bộ xả nhấn
Vòi lavabo nóng lạnh
H = 140, H1 = 75, L = 121



New
S393C
Sen nóng lạnh
Tay sen 03 chế độ



B570CP Bộ xả ty
B570CU Bộ xả nhấn
 Vòi lavabo nóng lạnh
 H = 161, H1 = 104, L = 120



S573C
 Sen nóng lạnh
 Tay sen 03 chế độ



B730CU Bộ xả nhấn
 Vòi lavabo nóng lạnh
 H = 145, H1 = 86, L = 109



S733C
 Sen nóng lạnh
 Tay sen 03 chế độ



B430CWU Bộ xả nhấn
 Vòi lavabo nóng lạnh - Sơn trắng
 H = 138, H1 = 60, L = 112



S433CWU
 Sen nóng lạnh - Sơn trắng
 Tay sen 03 chế độ



B170CU Bộ xả nhấn

Vòi lavabô nóng lạnh
H = 120, H1 = 50, L = 120



S173C

Sen nóng lạnh
Tay sen 03 chế độ



B740CU Bộ xả nhấn

Vòi lavabô nóng lạnh
H = 143, H1 = 108, L = 108



S743C

Sen nóng lạnh
Tay sen 03 chế độ



B540CU Bộ xả nhấn 

Vòi lavabô nóng lạnh
H = 164, H1 = 84, L = 110



S543C 

Sen nóng lạnh
Tay sen 01 chế độ



B230CU Bộ xả nhấn 

Vòi lavabô nóng lạnh
H = 148, H1 = 65, L = 110



S233C 

Sen nóng lạnh
Tay sen 03 chế độ



B590CU Bộ xả nhấn 

Vòi lavabô nóng lạnh
H = 158, H1 = 94, L = 92



S593C 

Sen nóng lạnh
Tay sen 03 chế độ



B460CU Bộ xả nhấn 

Vòi lavabô nóng lạnh
H = 165, H1 = 80, L = 125



S463C 

Sen nóng lạnh
Tay sen 03 chế độ



B640CU Bộ xả nhấn

Vòi lavabo nóng lạnh
H = 142, H1 = 75, L = 105



S643C

Sen nóng lạnh
Tay sen 01 chế độ



B770CU Bộ xả nhấn

Vòi lavabo nóng lạnh
H = 172, H1 = 75, L = 107



S773C

Sen nóng lạnh
Tay sen 03 chế độ



New

B061CU Bộ xả nhấn ●

Vòi lavabô lạnh cao
H = 316, H1 = 271, L = 109



B041CU Bộ xả nhấn ●

Vòi lavabô lạnh cao
H = 310, H1 = 270, L = 100



B571CU Bộ xả nhấn ●

Vòi lavabô nóng lạnh cao
H = 299, H1 = 243, L = 120



B228CU Bộ xả nhấn ●

Vòi lavabô nóng lạnh cao
H = 330, H1 = 175, L = 110



B541CU Bộ xả nhấn ●●

Vòi lavabô nóng lạnh cao
H = 314, H1 = 233, L = 110



B225CU Bộ xả nhấn ●●

Vòi lavabô nóng lạnh cao
H = 348, H1 = 235, L = 140



B551CU Bộ xả nhấn ●●

Vòi lavabô nóng lạnh cao
H = 337, H1 = 263, L = 117



B642CU Bộ xả nhấn ●●

Vòi lavabô nóng lạnh cao
H = 300, H1 = 205, L = 105



B421CU Bộ xả nhấn ●●

Vòi lavabô nóng lạnh cao
H = 348, H1 = 255, L = 109



B751CU Bộ xả nhấn ●●

Vòi lavabô nóng lạnh cao
H = 290, H1 = 191, L = 218



B229CU Bộ xả nhấn 

Vòi lavabo nóng lạnh
H = 155, H1 = 40, L = 115



B224CU Bộ xả nhấn 

Vòi lavabo nóng lạnh
H = 155, H1 = 50, L = 140



B136CU 

Vòi lavabo nóng lạnh
Bộ xả, dây sen, tay sen
H = 134, H1 = 63, L = 106



B680CT Bộ xả nhấn 

Vòi lavabo nóng lạnh
Vòi đèn (không dùng điện)
H = 130, H1 = 100, L = 120

B900C Bộ xả nhân

Vòi lavabo nóng lạnh
H - 233, H1 - 191, L - 149





New **K905C**
Vòi bếp nóng lạnh
H = 467, H1 = 255, L = 230



New **K915C**
Vòi bếp nóng lạnh
H = 319, H1 = 279, L = 193



New **K415C**
Vòi bếp nóng lạnh
H = 307, H1 = 208, L = 168



New **K815C**
Vòi bếp nóng lạnh
H = 352, H1 = 247, L = 182



K665C
Vòi bếp nóng lạnh
H = 282, H1 = 263, L = 203



K325C
Vòi bếp nóng lạnh
H = 355, H1 = 216, L = 213



K695C
Vòi bếp nóng lạnh
H = 329, H1 = 214, L = 180



K685C
Vòi bếp nóng lạnh
H = 306, H1 = 217, L = 206



K540C
Vòi bếp nóng lạnh
Gắn tường
L = 275



K376C
Vòi bếp nóng lạnh
Gắn tường
L = 301



K526C
Vòi bếp nóng lạnh
Gắn tường
H = 285, H1 = 130, L = 150
(ống mềm, đầu vòi điều chỉnh được)



New **K535C**
Vòi bếp nóng lạnh
Gắn tường
H = 246, H1 = 187, L = 184



K745C
Vòi bếp nóng lạnh
Hai nguồn cấp
H = 191, H1 = 154, L = 249



K511C
Vòi bếp nóng lạnh
H = 120, H1 = 130, L = 220



K375C
Vòi bếp nóng lạnh
H = 135, H1 = 110, L = 240



K035C

Vòi bếp lạnh
Không gồm dây cấp
H = 321, H1 = 244, L = 151



K036C

Vòi bếp lạnh - Gắn tường
H = 295, H1 = 177, L = 146



K027C

Vòi bếp lạnh
Không gồm dây cấp
H = 300, H1 = 200, L = 200



K022C

Vòi bếp lạnh
Không gồm dây cấp
H = 287, H1 = 227, L = 202



K025C

Vòi bếp lạnh
Không gồm dây cấp
Đầu vòi 2 chế độ - ống mềm
H = 260, H1 = 85, L = 120



K026C

Vòi bếp lạnh - Gắn tường
Đầu vòi 2 chế độ - ống mềm
H = 275, H1 = 135, L = 255



B040C

Vòi lavabô lạnh
Không gồm bộ xả
H = 103, H1 = 65, L = 80



B041CU

Vòi lavabô lạnh - Vòi cao
Bộ xả nhấn
H = 310, H1 = 270, L = 100



S043C Tay sen xi
S043CP Tay sen nhựa

Vòi sen lạnh
Tay sen 01 chế độ



B037C

Vòi lavabô lạnh
Không gồm bộ xả
H = 75, H1 = 32, L = 84



B027C

Vòi lavabô lạnh
Không gồm bộ xả
H = 75, H1 = 32, L = 84



S038C Tay sen xi
S038CP Tay sen nhựa

Vòi sen lạnh
Tay sen 01 chế độ



New

B060C

Vòi lavabô lạnh
Không gồm bộ xả
H = 141, H1 = 96, L = 109



New

B061CU

Vòi lavabô lạnh - Vòi cao
Bộ xả nhấn
H = 316, H1 = 271, L = 109



New

S063C Tay sen xi
S063CP Tay sen nhựa

Vòi sen lạnh
Tay sen 01 chế độ



B054CU

Vòi lavabô lạnh
Vòi nhấn tự động ngắt
Bộ xả nhấn nhựa
H = 147, H1 = 72, L = 97



B053CU

Vòi lavabô lạnh
Vòi nhấn tự động ngắt
Bộ xả nhấn nhựa
H = 86, H1 = 22, L = 111



S108C

Vòi sen lạnh
Tay sen 01 chế độ



B109C Không gồm bộ xả
B109CP Bộ xả ty nhựa
B109CU Bộ xả nhớt nhựa

Vòi lavabô lạnh
 H=140, H1=45, L=130



B065C

Vòi lavabô lạnh
 Không gồm bộ xả
 H=103, H1=40, L=95



B075C

Vòi lavabô lạnh
 Không gồm bộ xả
 H=129, H1=58, L=103



B076C

Vòi lavabô lạnh
 Không gồm bộ xả
 H=137, H1=82, L=92



B101C

Vòi lavabô lạnh
 Không gồm bộ xả
 H=76, H1=34, L=124



B104C

Vòi lavabô lạnh
 Không gồm bộ xả
 H=76, H1=34, L=118



B105C

Vòi lavabô lạnh
 Không gồm bộ xả
 H=90, H1=48, L=100



W047C

Vòi tường lạnh - Ø21



W054

Vòi tường lạnh - Ø21
 Vòi nhấn tự động ngắt



W038C

Vòi tường lạnh
 Không dây, tay, pát sen



W037C

Vòi tường lạnh - Ø21



WP037C

Vòi tường lạnh - Ø21



W038CP

Vòi tường lạnh
 Không dây, tay, pát sen



W027C

Vòi tường lạnh - Ø21



WP027C

Vòi tường lạnh - Ø21



WL027C

Vòi tường lạnh - Ø21



W034-1 / W035-1

Vòi tường lạnh - Ø21 / Ø27



W034 / W035

Vòi tường lạnh - Ø21 / Ø27



SH510
Tay sen 01 chế độ



SH212
Tay sen 01 chế độ



SH110
Tay sen 01 chế độ



SH221
Tay sen 02 chế độ



SH335
Tay sen 03 chế độ



SH133
Tay sen 03 chế độ



Tay sen nhựa
① **50211MCW**
Pát sen nhựa
② **51100MCW**
Dây sen nhựa
③ **13505MCW**



Tay sen nhựa
① **SH211W**
Pát sen nhựa
② **51100MCW**
Dây sen nhựa
③ **13505MCW**



Đầu vòi bếp
① **BF520**
Ống mềm vòi bếp
② **13332MAC**



BS304A
Vòi xịt nhựa - Dây nhựa



BS306A
Vòi xịt Nhựa - Dây nhựa



BS304B
Vòi xịt nhựa - Dây xi



BS306B
Vòi xịt nhựa - Dây xi



BS304CW
Vòi xịt xi - Dây xi



BF423
Dây cấp nhựa - Ø 21 - dài 300mm



BF403P
Van khống chế nhựa - Ø 21



BF427P
Van khống chế T nhựa - Ø 21



BF422
Dây cấp xi - Ø 21 - dài 400mm



BF403
Van khống chế xi - Ø 21



BF427
Van khống chế T xi - Ø 21

Phụ kiện



BF602
Bộ xả nhựa



BF603
Bộ xả ty xi



BF605
Bộ xả nhựa nhua



BF606
Bộ xả ti nhựa



BF404H
Trụ xả nắp sứ



BF405P
Cổ P xi



13608MDA
Dây sen xi - Ø21
Dài 1.5m



51100MCC
Pát đỡ tay sen xi



WG117
Thanh trượt tay sen xi
75 x 705 mm



Bồn tắm massage đèn

- Bồn Tắm Massage đèn tái tạo khí có lợi cho sức khỏe.
- Tia massage phun mọi hướng giúp giảm mệt mỏi và tạo cảm giác bập bênh như sóng biển.
- Sự kết hợp hài hòa của bọt nước và ánh đèn tạo ra sự hưng phấn trong không gian lãng mạn đầy màu sắc.

Chức năng nút điều khiển cảm ứng:

Khi có nguồn điện nút cảm ứng có màu xanh dương

Đèn sáng theo màu lần lượt theo thứ tự chạm :

lần 1 đỏ - lần 2 xanh dương - lần 3 xanh lá - lần 4 tím - lần 5 vàng - lần 6 xanh ngọc - lần 7 tím nhạt - lần 8 tự động mờ đi và chuyển sang màu kế tiếp theo thứ tự trên - lần 9 tắt đèn



MT7180C
MT7180L(R)CH



- o Bồn tắm đôi massage đèn
- Dung lượng nước : 340 lít
- 180 x 120 x 55 cm
- 180 x 120 x 55 cm



MT0660C
AS489C



- o Bồn tắm massage đèn
- Dung lượng nước : 160 lít
- 165 x 85 x 52 cm
- o Với bồn tắm



Ghi chú

- A** Bồn tắm xây
- B** Bồn tắm chân yếm
- C** Bồn tắm massage xây
- CS** Bồn tắm massage hai xây
- D** Bồn tắm massage chân yếm
- DS** Bồn tắm massage hai chân yếm



MT7520 **C**
MT7520S **CS**

- o Bồn tắm massage
- Dung lượng nước : 260 lít
- 200 x 110 x 55 cm
- 200 x 110 x 55 cm



MT212 **C**

- o Bồn tắm massage
- Dung lượng nước : 220 lít
- 200 x 105 x 55 cm



MT6470A **C**
MT6470 **D**

- o Bồn tắm tròn massage
- Dung lượng nước : 500 lít
- 179 x 179 x 68 cm
- 179 x 179 x 68 cm



MT5165 **D**

- o Bồn tắm đôi - góc massage
- Dung lượng nước : 400 lít
- 167 x 167 x 78 cm

AT0770
MT0770
AS489C

B
D

- o Bồn tắm massage
- o Dung lượng nước : 180 lít
- o 175 x 80 x 60 cm
- o Vòi bồn tắm



AT6170
AS489C

B

- o Bồn tắm
- Dung lượng nước : 220 lít
- 170 x 87 x 60 cm
- o Vòi bồn tắm



AT6250
AS489C

B

- o Bồn tắm
- o Dung lượng nước : 220 lít
- o 155 x 85 x 54 cm
- o Với bồn tắm



AT6270
AS489C

B

- Bốn tấm
- Dung lượng nước : 220 lít
- 170 x 87 x 60 cm
- Vòi bốn tấm

KT1160
AS489C

B

- Bốn tấm ngồi
- Dung lượng nước : 160 lít
- 162 x 76 x 76 cm
- Vòi bốn tấm



AT6350

B

- o Bồn tắm
- Dung lượng nước : 200 lít
- 155 x 85 x 54 cm

Bồn tắm

Ghi chú

- A** Bồn tắm xây
- B** Bồn tắm chân yếm
- C** Bồn tắm massage xây
- CS** Bồn tắm massage hơi xây
- D** Bồn tắm massage chân yếm
- DS** Bồn tắm massage hơi chân yếm



KT1150

B

- o Bồn tắm ngồi
- Bao gồm vòi
- Dung lượng nước : 140 lít
- 150 x 75 x 78 cm



AT0950 AS143C

B

- o Bồn tắm
- Dung lượng nước : 220 lít
- 150 x 80 x 62 cm
- o Vòi bồn tắm



AT6480 MT6480

B

D

- o Bồn tắm massage
- Bao gồm vòi
- Dung lượng nước : 180 lít
- 180 x 95 x 65 cm



MT5132A
MT5132

C
D

- o Bồn tắm góc massage
Dung lượng nước : 210 lít
138 x 138 x 58 cm

MT5 150A
MT5 150

- Bồn tắm góc massage
Dung lượng nước : 272 lít
151 x 151 x 62 cm

C
D



MT5 120A
MT5 120

- Bồn tắm góc massage
Dung lượng nước : 155 lít
122 x 122 x 58 cm

C
D



AT5220

- Bồn tắm góc
Dung lượng nước : 220 lít
122 x 122 x 53 cm

B



MT5 140A
MT5 140

- Bồn tắm góc massage
Dung lượng nước : 220 lít
141 x 141 x 60 cm

C
D



MT5 133

- Bồn tắm góc massage
Dung lượng nước : 240 lít
134 x 134 x 65 cm

D





MT0440
MT0440L(R)



- Bồn tắm massage - xả trái
Dung lượng nước : 160 lít
141 x 76 x 58 cm

MT0460
MT0460L(R)



- Bồn tắm massage - xả trái
Dung lượng nước : 192 lít
161 x 76 x 58 cm



MT0640
MT0640L(R)



- Bồn tắm massage - xả trái
Dung lượng nước : 160 lít
141 x 76 x 55 cm

MT0650
MT0650L(R)



- Bồn tắm massage - xả trái
Dung lượng nước : 170 lít
151 x 76 x 55 cm

MT0670
MT0670L(R)



- Bồn tắm massage - xả trái
Dung lượng nước : 190 lít
171 x 76 x 55 cm



MT211AL(R)
MT211SAL(R)
MT211L(R)
MT211SL(R)



- Bồn tắm massage - xả trái
Dung lượng nước : 210 lít
172 x 90 x 60 cm

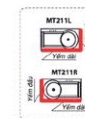

MT3370L(R)
MT3370SL(R)



- Bồn tắm massage - xả trái
Dung lượng nước : 230 lít
171 x 87 x 68 cm

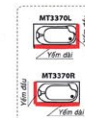



MT3350AL(R)
MT3350L(R)

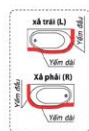

- Bồn tắm massage - xả trái
- Dung lượng nước : 160 lít
- 151 x 78 x 60 cm



MT0150
MT0150L(R)



- Bồn tắm massage - xả trái
- Dung lượng nước : 205 lít
- 151 x 76 x 54 cm

MT0170
MT0170L(R)



- Bồn tắm massage - xả trái
- Dung lượng nước : 240 lít
- 171 x 81 x 54 cm



MT0870
MT0870L(R)

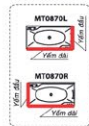

- Bồn tắm massage - xả trái
- Dung lượng nước : 250 lít
- 171 x 86 x 58 cm



MT0250
MT0250L(R)



- Bồn tắm massage - xả trái
- Dung lượng nước : 160 lít
- 151 x 76 x 54 cm

MT0270
MT0270L(R)



- Bồn tắm massage - xả trái
- Dung lượng nước : 192 lít
- 171 x 81 x 54 cm



MT0350
MT0350L(R)



- Bồn tắm massage - xả trái
- Dung lượng nước : 160 lít
- 151 x 76 x 54 cm

MT0370
MT0370L(R)



- Bồn tắm massage - xả trái
- Dung lượng nước : 192 lít
- 171 x 81 x 54 cm



MT0550
MT0550L(R)



- Bồn tắm massage - xả trái
- Dung lượng nước : 190 lít
- 152 x 73 x 56 cm

MT0570
MT0570L(R)



- Bồn tắm massage - xả trái
- Dung lượng nước : 240 lít
- 171 x 86 x 58 cm



AT2150L(R)



- Bồn tắm - xả trái
- Dung lượng nước : 160 lít
- 150 x 75 x 60 cm

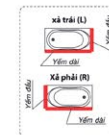

AT7135



- Bồn tắm xây
- Dung lượng nước : 280 lít
- 135 x 135 x 55 cm

Ghi chú

- A** Bồn tắm xây
- B** Bồn tắm chân yếm
- C** Bồn tắm massage xây
- CS** Bồn tắm massage hai xây
- D** Bồn tắm massage chân yếm
- DS** Bồn tắm massage hai chân yếm



Ghi Chú : Mã số của bồn tắm

1. Bắt đầu bằng 2 chữ **AT** là bồn tắm thường : AT0150, AT5150 ...
2. Bắt đầu bằng 2 chữ **MT** là bồn tắm massage : MT0350, MT5140 ...
3. Chữ cuối là chữ **L**(trái) (hoặc **R** (phải)) là bồn tắm có chân có yếm : AT0150L, AT0460R ...
4. Chữ cuối là chữ **S** là bồn tắm massage hơi : MT3370S, MT211S.
5. Chữ cuối là chữ **C** là bồn tắm massage đèn : MT7180C, MT0660C.
6. Bồn tắm góc có chữ **A** cuối là bồn tắm góc không chân không yếm.
7.  Vị trí ổ cắm điện 220V cách nền hoàn thiện 300mm
8.  Vị trí cấp nước nóng lạnh cách nền hoàn thiện 300mm
9. Chờ ống thoát nước Ø60.

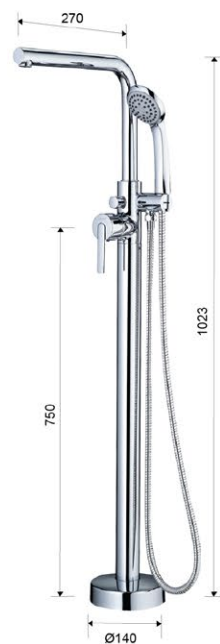
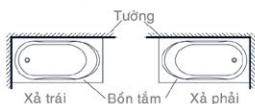

AS489C

- Vòi sen bồn tắm nóng lạnh
H = 1023, H1 = 990, L = 240



AS111C

- Bộ vòi sen trên bồn tắm



AS143C

- Bộ vòi sen trên bồn tắm



S143C

- Vòi sen nóng lạnh
Tay sen 03 chế độ



S733C

- Vòi sen nóng lạnh
Tay sen 03 chế độ



SPR101

- Cửa tắm đứng - cửa lùa
- Kính cường lực 6mm
- Khay đứng : sợi nhựa tổng hợp Acrylic
- Khung cố định sơn tĩnh điện
- 90 x 90 x 198 cm



AS200

- Khay tắm đứng
- Bao gồm bộ xả
- 101.5 x 101.5 x 15 cm



AS190

- Khay tắm đứng
- Bao gồm bộ xả
- 91 x 91 x 10 cm

**SD4320AT-RI**

- o Cửa tắm đứng - cửa mở vào
- Kính cường lực 8mm
- Khay đứng : sợi nhựa tổng hợp Acrylic
- Phụ kiện inox - Khung cố định nhôm
- 100 x 100 x 215 cm

**SD5320AT-RO**

- o Cửa tắm đứng - cửa mở ra
- Kính cường lực 8mm
- Khay đứng : sợi nhựa tổng hợp Acrylic
- Phụ kiện inox - Khung cố định nhôm
- 100 x 100 x 215 cm

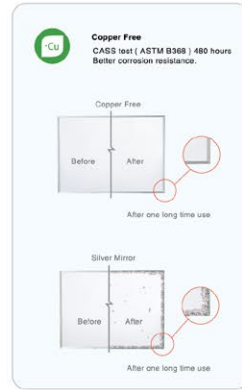

M763
 Guong trang điểm - Hai mặt
 300 x 28 x 220 mm



M926 **Cu**
 Guong soi : 800 x 900 mm
 Khung nhựa cao cấp



M936 **Cu**
 Guong soi : 600 x 800 mm
 Khung nhựa cao cấp



M937 **Cu**
 Guong soi : 600 x 800 mm
 Khung nhựa cao cấp



M810 **Cu**
 Guong soi : 600 x 800 mm
 Khung nhựa cao cấp



M803 **Cu**
 Guong soi : 600 x 800 mm
 Khung nhựa cao cấp



M804 **Cu**
 Guong soi : 500 x 700 mm
 Khung nhựa cao cấp



M927 **Cu**
 Guong soi : 500 x 700 mm
 Khung nhựa cao cấp



Q1235
Tủ treo
150 x 200 x 700 mm



Q1230
Tủ treo
150 x 200 x 800 mm



M941
Gương + kệ
110 x 600 x 600 mm



New

EM0145W
Tủ Gương
170 x 450 x 640 mm





M110

Gương soi : 450x600mm



M111

Gương soi : 450x600mm



M112

Gương soi : 450 x 600 mm



M113

Gương soi : 450 x 600 mm



M116

Gương soi : 600 x 450 mm



M121

Gương soi : 500 x 700 mm



M114

Gương soi : 800 x 600 mm



M119

Gương soi : 450 x 600 mm



M753V

Gương soi : 600 x 450 mm
Bao gồm : M116+Q760V



M710

Gương soi : 800 x 600 mm
Bao gồm : M114+Q780V



Q760V

Kệ gương : 140 x 600 x 8 mm



Q780V

Kệ gương : 140 x 800 x 8 mm



Bộ phụ kiện **Q7300-A7**

Q7300V

Kệ gương - 600mm



Q7301V

Thanh treo khăn - 690mm



Q7307V

Móc áo



Q7302V

Kệ xà phòng



Q7303V

Kệ để bàn chải răng



Q7304V

Hộp đựng giấy vệ sinh



Q7305V

Vòng treo khăn



Bộ phụ kiện **Q8300-A7**

Q8300

Kệ gương - 600mm



Q8301

Thanh treo khăn - 720mm



Q8307

Móc áo



Q8302

Kệ xà phòng



Q8303

Kệ để bàn chải răng



Q8304

Hộp đựng giấy vệ sinh



Q8305

Vòng treo khăn





Bộ phụ kiện **Q7710-A6**

Q7710V

Kệ gương - 600mm



Q7711V

Thanh treo khăn - 670mm



Q7712V

Kệ xà phòng



Q7713V

Kệ để bàn chải răng



Q7714V

Hộp đựng giấy vệ sinh



Q7715V

Vòng treo khăn



Bộ phụ kiện **Q8800-A6**

Q8800

Kệ gương - 600mm



Q8801

Thanh treo khăn - 750mm



Q8802

Kệ xà phòng



Q8803

Kệ để bàn chải răng



Q8804

Hộp đựng giấy vệ sinh



Q8807

Móc áo





Bộ phụ kiện Q940-A7

Q940

Kệ gương - 600mm



Q941

Thanh treo khăn đôi - 840mm



Q947

Móc áo bằng sứ



Q942

Kệ xà phòng



Q943

Kệ để bàn chải răng



Q944

Hộp đựng giấy vệ sinh



Q948

Vòng treo khăn



Bộ phụ kiện Q990-A6

Q990

Kệ gương - 600mm



Q991

Thanh treo khăn đôi - 750mm



Q997

Móc áo



Q992

Kệ xà phòng



Q993

Kệ để bàn chải răng



Q994

Hộp đựng giấy vệ sinh





ST857

Móc áo inox - 5 móc
42x352x40mm



ST858

Móc áo inox - 7 móc
42x510x40mm



ST859

Kệ inox chữ nhật 2 tầng
155x260x330mm



ST830V

Kệ inox chữ nhật
155x260x50mm



ST831V

Kệ inox góc
200x200x50mm



ST849

Kệ inox góc 2 tầng
250x250x330mm



ST810V

Kệ inox góc 2 tầng
285x285x415mm



ST823V

Kệ inox góc
230x230x90mm

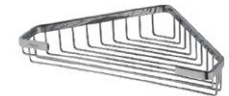

ST854

Kệ inox góc
250x250x50mm



ST881V

Kệ treo khăn - Inox
250 x 600 x 165 mm



Q924V

Kệ treo khăn - Inox
250 x 630 x 185 mm



Q7209V

Kệ treo khăn - Inox
250 x 620 x 100 mm



ST834V

Kệ treo khăn - Inox
235 x 630 x 140 mm

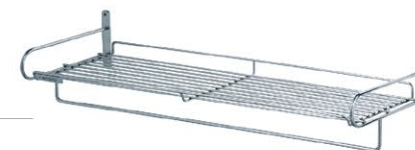

ST827V

Kệ treo khăn - Inox
220 x 610 x 175 mm



ST129

Dây phơi dạng cuộn 2.5m
93 x 93 x 58 mm



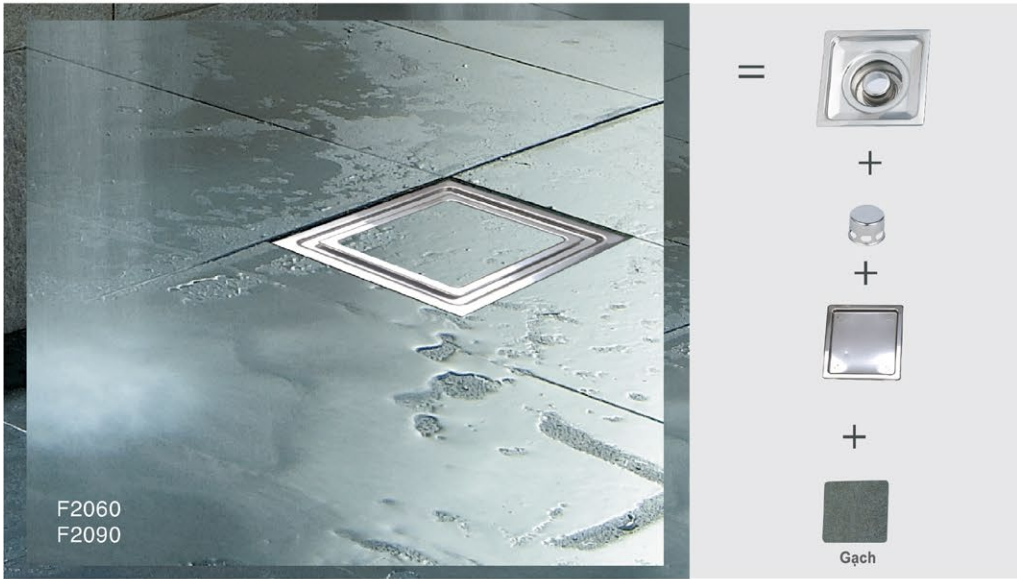

F2060
F2090

Thoát sàn được thiết kế đặc biệt cho các công trình cao cấp với bộ phận ngăn mùi đặc biệt:

- Chất liệu : **Inox 304**
- Ngăn mùi hiệu quả.
- Thoát nước nhanh.
- Đặc biệt mang tính thẩm mỹ cao.



F2060 Ø 60
F2090 Ø 90

Thoát sàn - Inox
Không bao gồm gạch
200 x 200 mm



ST1010E Ø 60

Thoát sàn - Inox
100 x 100 mm



ST1212E Ø 60
ST1212EL Ø 90

Thoát sàn - Inox
120 x 120 mm



ST1414E Ø 60
ST1414EL Ø 90

Thoát sàn - Inox
140 x 140 mm



F2323A Ø 90

Cấu chuẩn rác - Inox
115 x 115 mm



F2222 Ø 60

Thoát sàn - Inox
90 x 90 mm



ST1010B Ø 60

Thoát sàn - Inox
100 x 100 mm



ST1212 Ø 60
ST1212L Ø 90

Thoát sàn - Inox
120 x 120 mm



ST1414 Ø 60
ST1414L Ø 90

Thoát sàn - Inox
140 x 140 mm



ST1030B Ø 60

Thoát sàn - Inox
100 x 300 mm



ST1060B Ø 60

Thoát sàn - Inox
100x600mm



GB100V Ø 32

Thanh vịn - Inox
780 x 155 x 220 mm

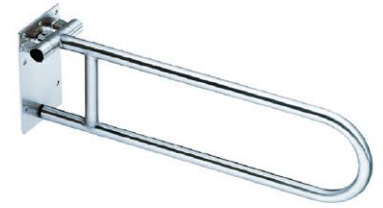

GB104V Ø 32

Thanh vịn - Inox
750 x 750 mm



GB102V Ø 32

Thanh vịn - Inox
698 x 750 mm



GB131V Ø 32

Thanh vịn - Inox
700 mm



GB135V Ø 32

Thanh vịn - Inox
410 x 410 mm



ST127

Hộp giấy vệ sinh - Inox
80 x 260 x 210 mm



H108

Hộp giấy vệ sinh
120 x 263 x 275 mm



ST850

Kệ inox đựng hộp giấy



Q831

Hộp xả phòng
85 x 75 x 230 mm



Q832

Hộp xả phòng đôi
85 x 150 x 230 mm



ST005

Hộp xả phòng
132 x 94 x 170 mm



Q999

Kệ sứ góc
260 x 260 x 50 mm



Q945

Cọ vệ sinh bàn cầu

SIAA
ISO 22196
for KOHKIN
TW0122339X0001T

Nắp bồn cầu kháng khuẩn Caesar

Đạt chứng nhận kháng khuẩn SIAA Nhật Bản (Hiệp hội sản phẩm công nghệ kháng khuẩn Nhật Bản)

Tỉ lệ kháng khuẩn 99% (Chủng khuẩn thử nghiệm : E.coli và Tụ cầu vàng)

Nắp bồn cầu kháng khuẩn Caesar



CD1363



CD1375



CD1340



CD1341



CD1345



CD1348



CD1349



CD1320

Nắp bồn cầu



M220

Nắp thường thích hợp với
CT1325, CD1325, CT1338
CD1338, CPT1332, CPI1333



MS220

Nắp êm thích hợp với
CTS1325, CDS1325, CTS1338
CDS1338, CPT1332, CPI1333



M221

Nắp êm thích hợp với
CD1320, CD1363, CD1375
(CD1340, CD1341, CD1348
, CD1356)



M232

Nắp êm thích hợp với
CD1331, CD1340, CD1341
CD1345, CD1348, CD1349
CD1530, CD1375



MU234

Nắp êm thích hợp với
CD1364, C1353



MU235

Nắp êm thích hợp với
CD1374



M236

Nắp êm thích hợp với
CD1347, CD1346



MU237

Nắp êm thích hợp với
CD1551



M243

Nắp êm thích hợp với
CPT1503



M256

Nắp êm thích hợp với
CD1356



M284

Nắp êm thích hợp với
C1352



M282

Nắp êm thích hợp với
CT1026

Bản Vẽ Kỹ Thuật

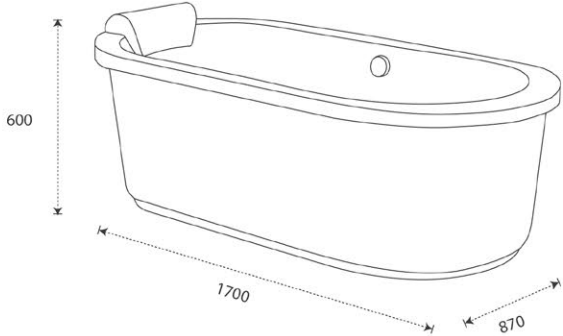
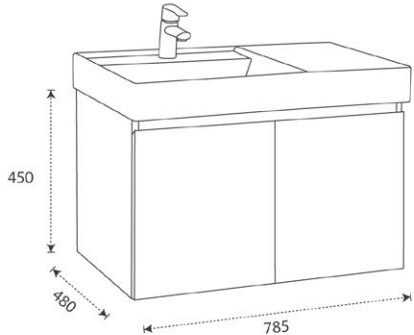
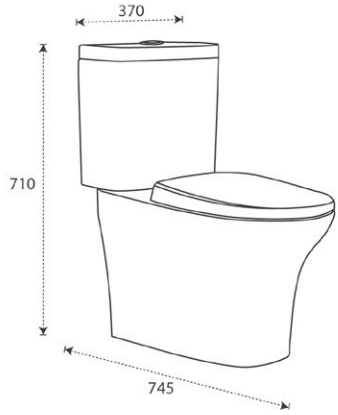
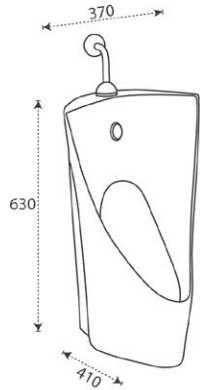



CA1380H

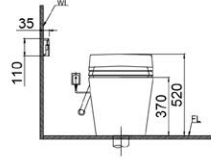
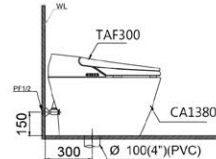
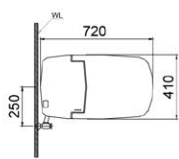

C1353

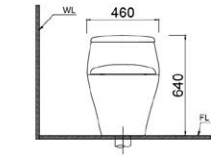
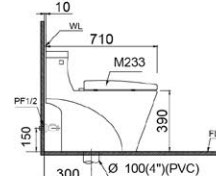
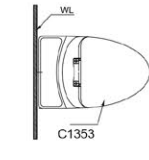

CD1356

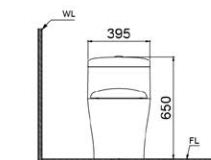
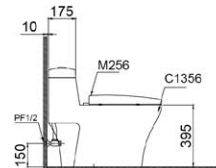
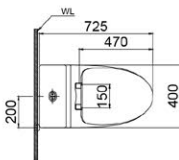

CD1363

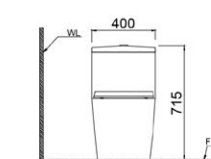
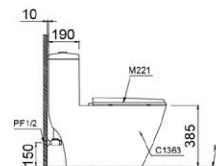
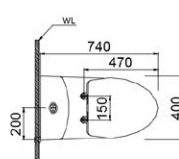

CD1364

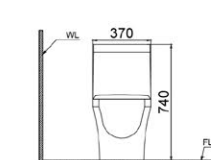
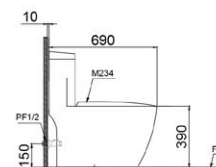
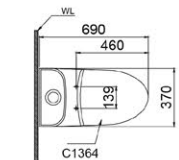

CD1374

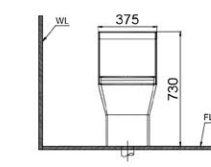
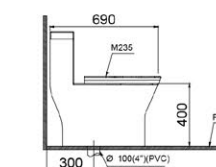

CD1375

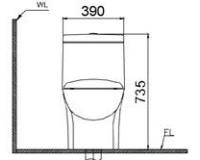
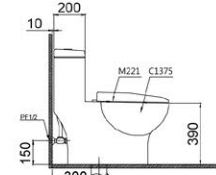
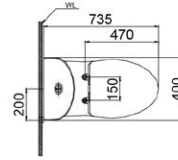

CD1340

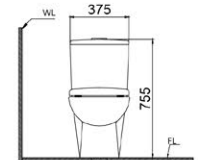
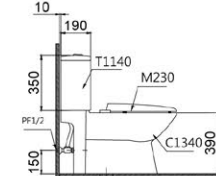
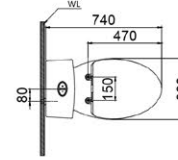

CD1341

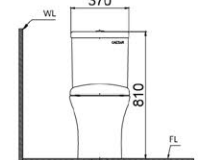
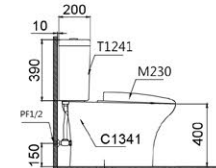
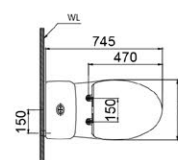

CD1345

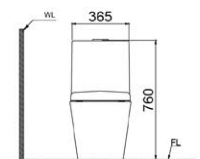
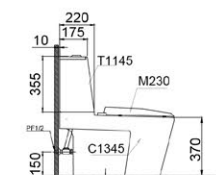
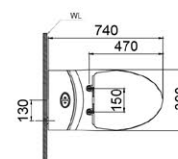

CD1346

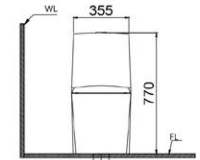
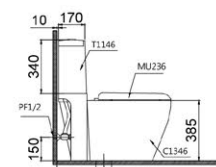
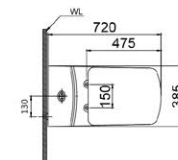

CD1348

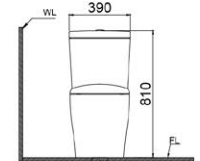
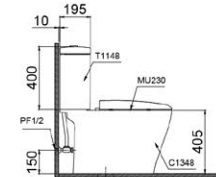
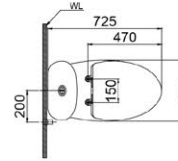

CS1230

CP1333 + BF443

C1250 + BF446

C1230 + BF449

C1352

CT1026

U0232 A654













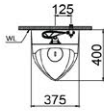
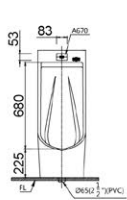
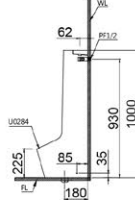

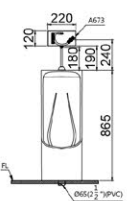
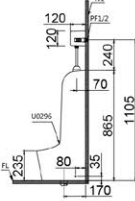

U0235 A654

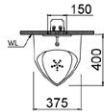
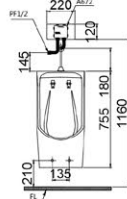
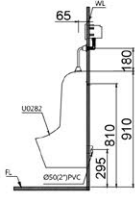

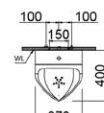
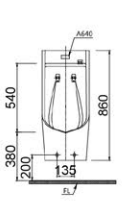
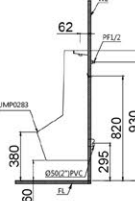

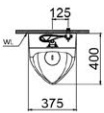
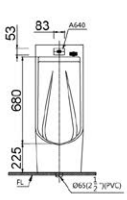
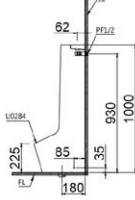



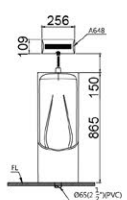
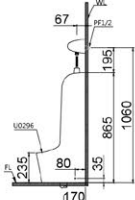

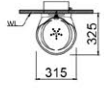
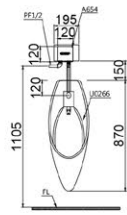
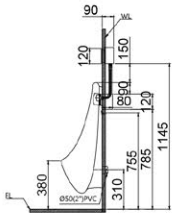

U0239 A654

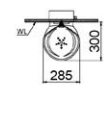
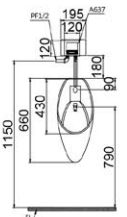
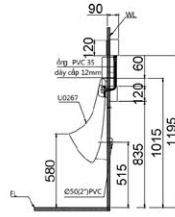
UA0234 A655B-RA

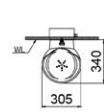
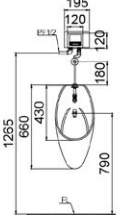
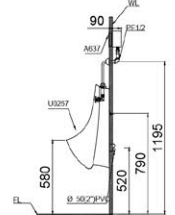
UA0237 A655B-RA

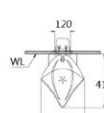
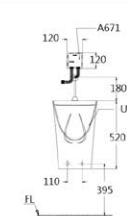
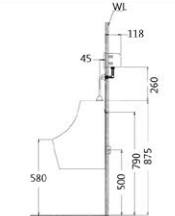
UMP0283 A670

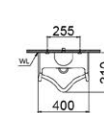
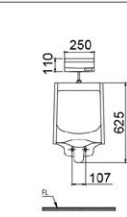
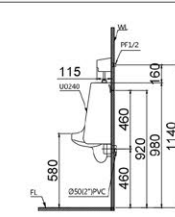
 <p>UMP0284 A670</p>				
 <p>U0296 A673</p>				
 <p>U0282 A654</p>				
 <p>UA0283 A640</p>				
 <p>UA0284 A640</p>				
 <p>U0296 A648</p>				

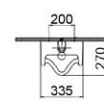
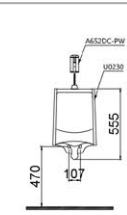
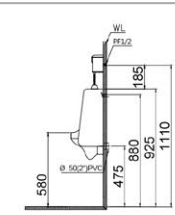
 <p>U0266 A654</p>				
 <p>U0264 A637</p>				
 <p>U0267 A637</p>				
 <p>U0233 A637</p>				
 <p>U0240 A623</p>				
 <p>U0230 A652DC-PW</p>				

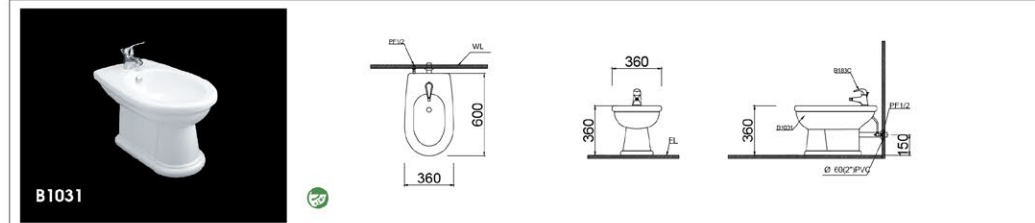
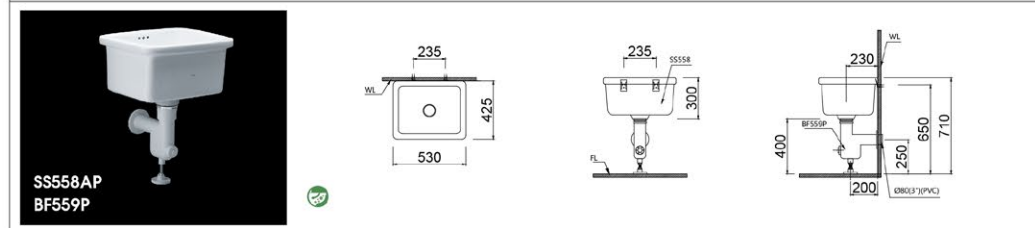
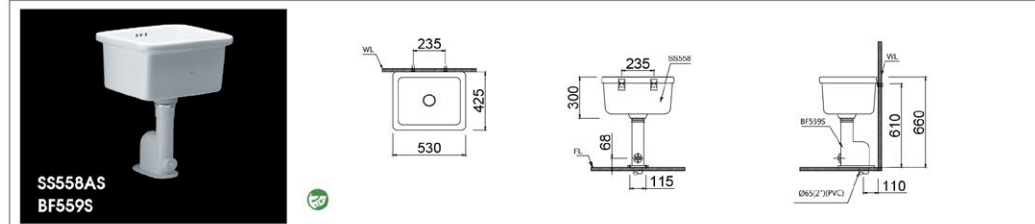
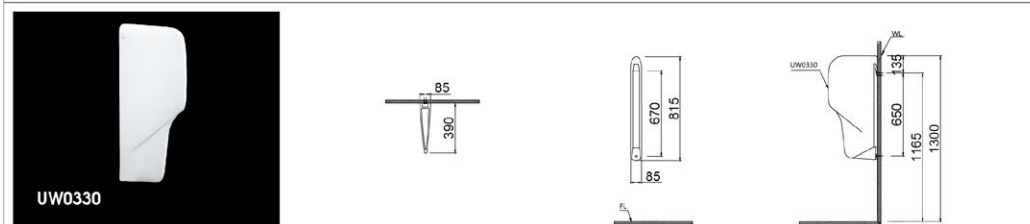
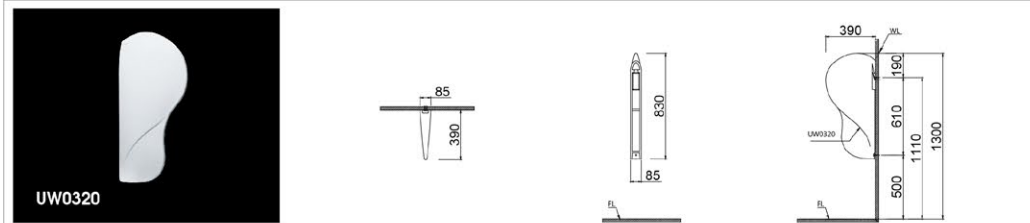
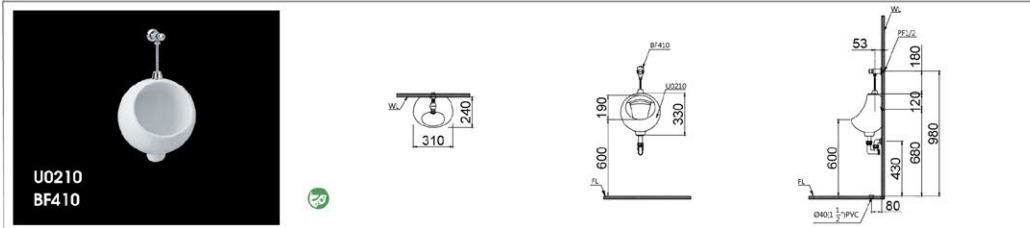
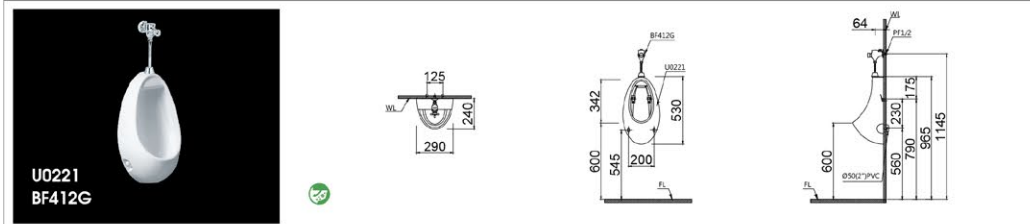



**LF5253
EH05253A**

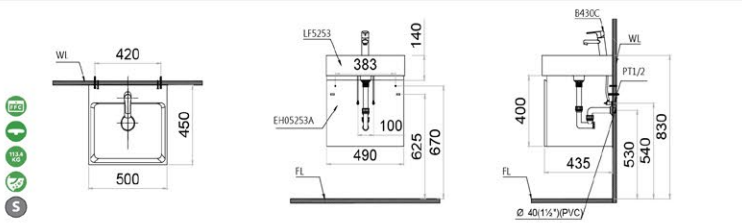

Technical specifications: $\varnothing 40(1\frac{1}{2})\text{(PVC)}$



**LF5255
EH05255A**

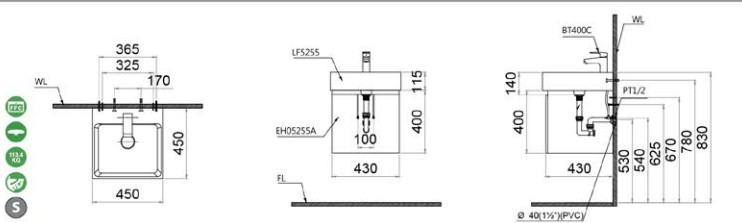

Technical specifications: $\varnothing 40(1\frac{1}{2})\text{(PVC)}$



**LF5257
EH05257A**

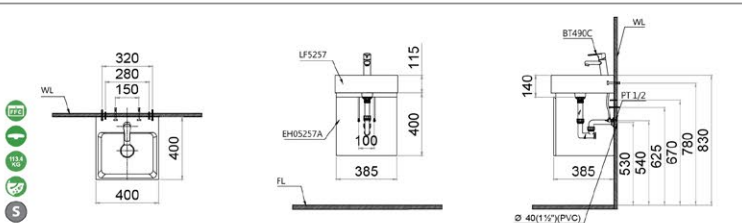

Technical specifications: $\varnothing 40(1\frac{1}{2})\text{(PVC)}$



**LF5259
EH05259A**

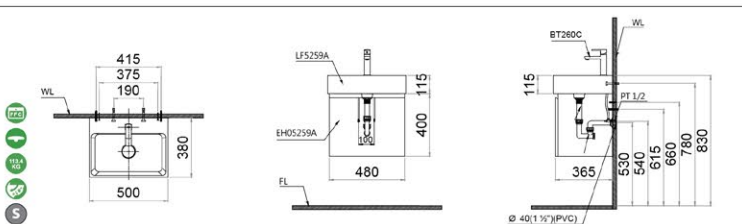

Technical specifications: $\varnothing 40(1\frac{1}{2})\text{(PVC)}$



**L5261
EH05261A**

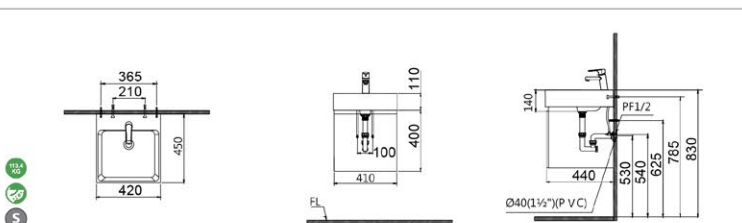

Technical specifications: $\varnothing 40(1\frac{1}{2})\text{(PVC)}$



**LF5380
EH05380A**

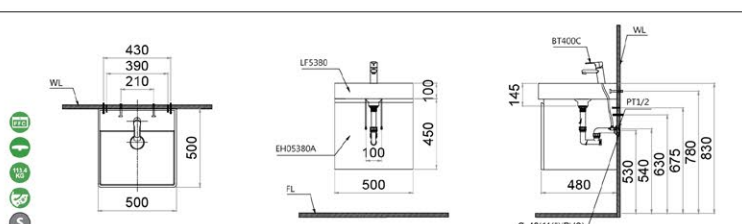

Technical specifications: $\varnothing 40(1\frac{1}{2})\text{(PVC)}$



**LF5382
EH05382A**

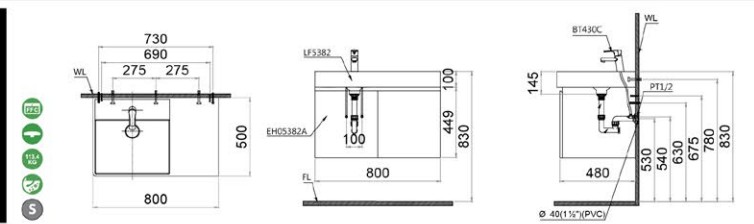

Technical specifications: $\varnothing 40(1\frac{1}{2})\text{(PVC)}$



**LF5384
EH05382A**

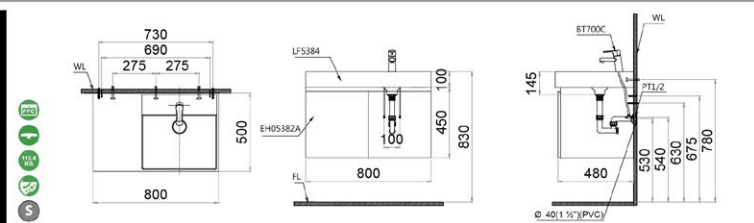

Technical specifications: $\varnothing 40(1\frac{1}{2})\text{(PVC)}$



**LF5386
EH05386A**

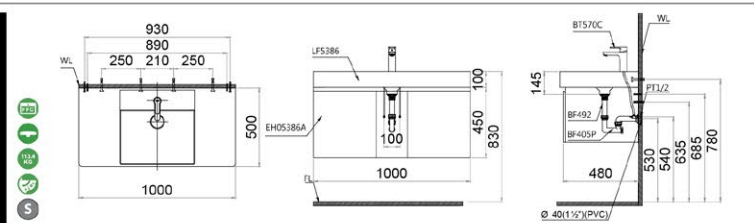

Technical specifications: $\varnothing 40(1\frac{1}{2})\text{(PVC)}$



**LF5388
EH05388A**

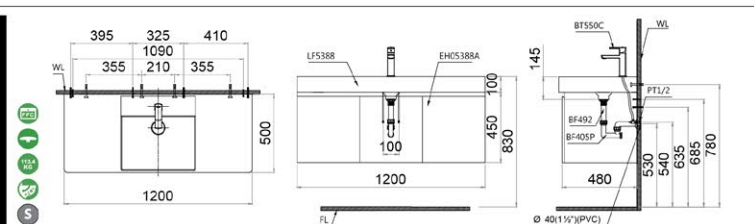

Technical specifications: $\varnothing 40(1\frac{1}{2})\text{(PVC)}$



**LF5370
EH05370A**

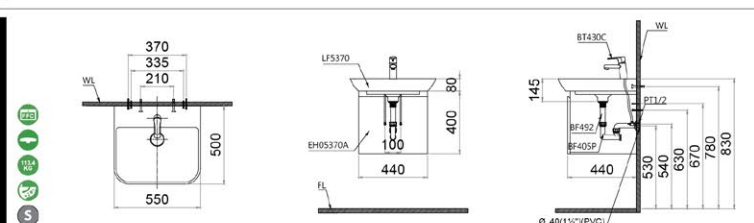

Technical specifications: $\varnothing 40(1\frac{1}{2})\text{(PVC)}$



**LF5372
EH05372A**

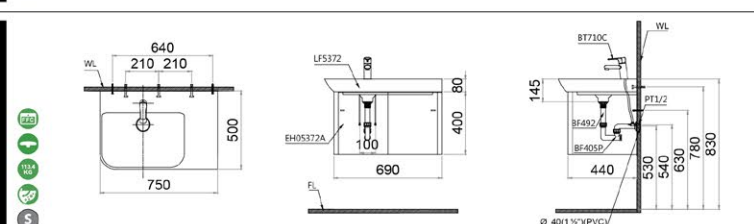

Technical specifications: $\varnothing 40(1\frac{1}{2})\text{(PVC)}$

LF5374
EH05374A

LF5376
EH05376A

LF5036
EH05036AV

LF5368
EH05368AD

LF5362
EH05362AD

LF5364
EH05362AD

LF5024
EH05024DDV

LF5026
EH05026DDV

LF5028
EH05028DDV

LF5030
EH05030DDV

LF5032
EH05032DDV

LF5324
EH05324AV

LF5236
EH05236AV

LF5302
EH05302AV

LF5239S
EH05239AV

LF5024
EH05024AV

LF5038
EH05038AV

L5018

LF5016

L5115

L5113

L5125

LF5127

LF5118

LF5128

LF5130

L2014

LF5238

L2140

LF5239S

L2150 P2441

L2152 P2443

L2220 P2436

LF2270 PF2470

L2140 P2440

L2150 P2440

**L2152
P2445**

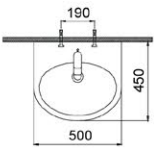
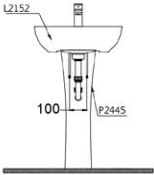
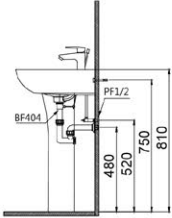
190
450
500
100
P2445
BF404
PF1/2
480
520
750
810

**L2220
P2437**



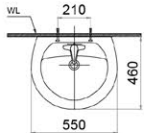
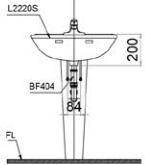
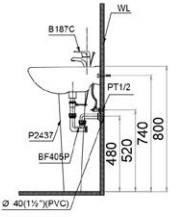

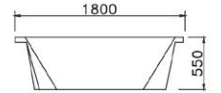
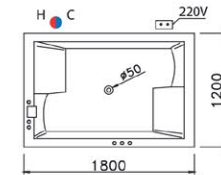

210
460
550
200
B187C
WL
L2220S
PF1/2
P2437
BF404SP
BF404
480
520
740
800
Ø 40(1 1/2" PVC)

MT7180RCH
- Bộ xả : 82600008

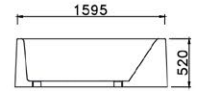
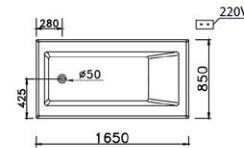
MT0660C
- Bộ xả : BF455

MT6470
- Bộ xả : 82600008

MT5165
- Bộ xả : BF455



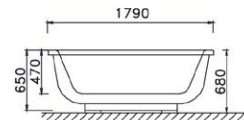
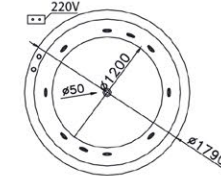

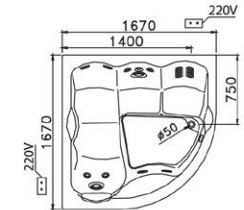

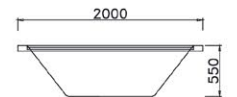
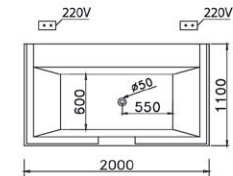

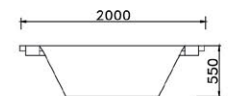
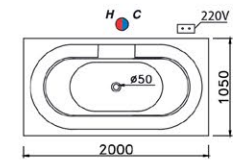

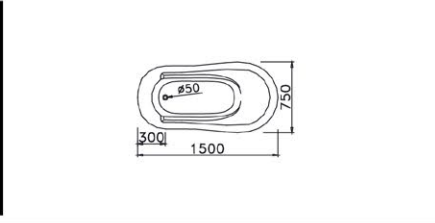
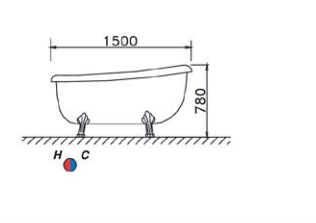

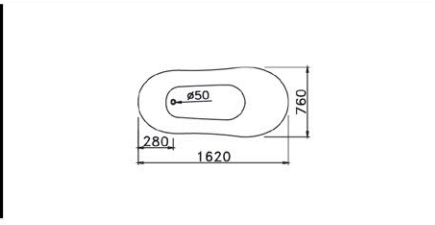
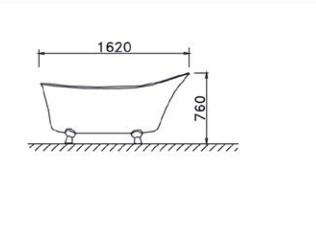

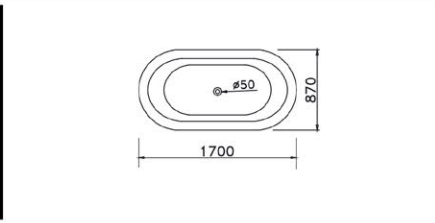
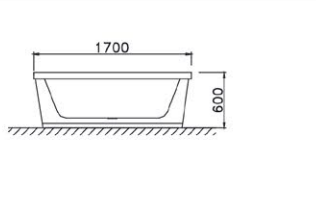

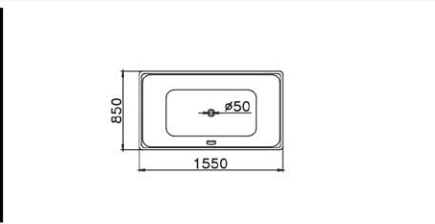
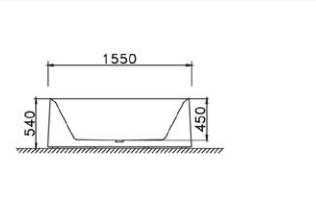

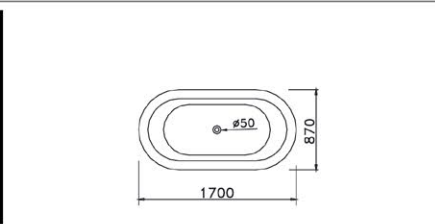
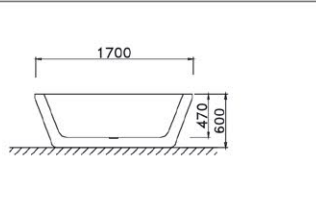

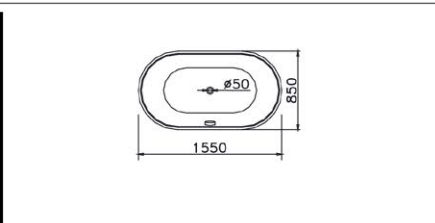
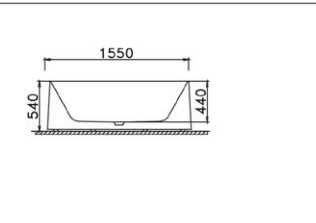

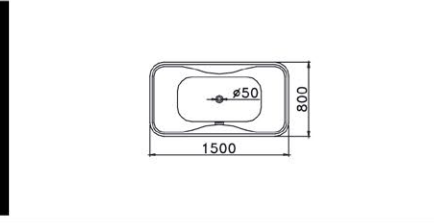
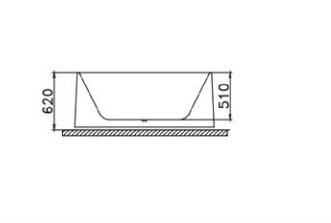

MT7520
- Bộ xả : BF455-75

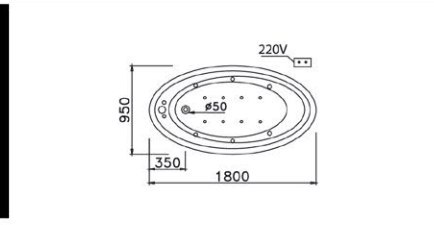
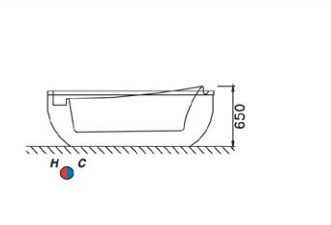

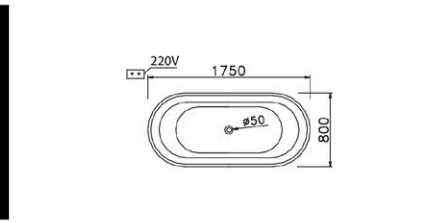
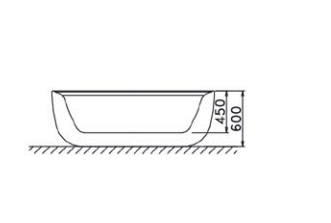

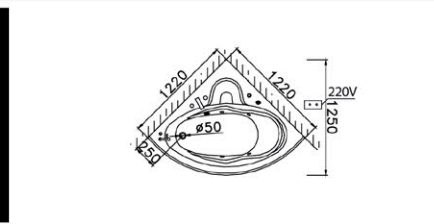
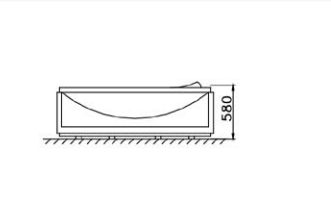
MT212
- Bộ xả : BF455-75
- Bộ vòi : AS105C

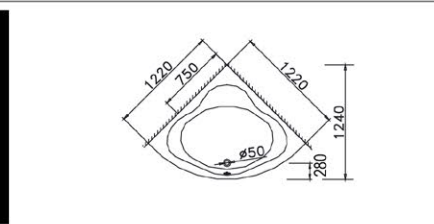
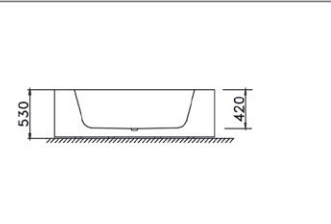

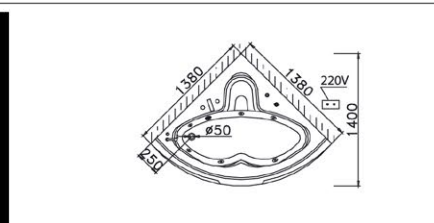
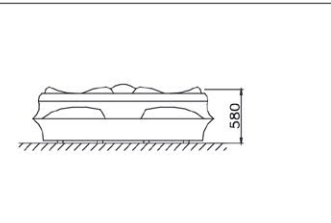

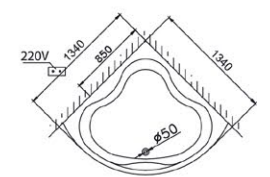
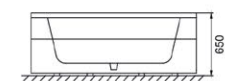
 <p>KT1150 - Bộ xả : BF455 - Bộ vòi : AS126C</p>	 <p>Technical drawing showing top view with dimensions: 1500 (length), 750 (width), and 300 (depth).</p>	 <p>Technical drawing showing side view with dimensions: 1500 (length), 780 (height), and mounting points H and C.</p>
 <p>KT1160 - Bộ xả : BF455</p>	 <p>Technical drawing showing top view with dimensions: 1620 (length), 760 (width), and 280 (depth).</p>	 <p>Technical drawing showing side view with dimensions: 1620 (length), 760 (height), and mounting points H and C.</p>
 <p>AT6170 - Bộ xả : BF455-75</p>	 <p>Technical drawing showing top view with dimensions: 1700 (length), 870 (width), and 50 (drain diameter).</p>	 <p>Technical drawing showing side view with dimensions: 1700 (length), 600 (height), and mounting points H and C.</p>
 <p>AT6250 - Bộ xả : BF455-75A</p>	 <p>Technical drawing showing top view with dimensions: 1550 (length), 650 (width), and 50 (drain diameter).</p>	 <p>Technical drawing showing side view with dimensions: 1550 (length), 540 (height), 450 (height), and mounting points H and C.</p>
 <p>AT6270 - Bộ xả : BF455-75</p>	 <p>Technical drawing showing top view with dimensions: 1700 (length), 870 (width), and 50 (drain diameter).</p>	 <p>Technical drawing showing side view with dimensions: 1700 (length), 600 (height), 470 (height), and mounting points H and C.</p>
 <p>AT6350 - Bộ xả : BF455-75A</p>	 <p>Technical drawing showing top view with dimensions: 1550 (length), 650 (width), and 50 (drain diameter).</p>	 <p>Technical drawing showing side view with dimensions: 1550 (length), 540 (height), 440 (height), and mounting points H and C.</p>

 <p>AT0950 - Bộ xả : BF455-75 - Bộ vòi : AS143C</p>	 <p>Technical drawing showing top view with dimensions: 1500 (length), 800 (width), and 50 (drain diameter).</p>	 <p>Technical drawing showing side view with dimensions: 620 (height), 510 (height), and mounting points H and C.</p>
 <p>MT6480 - Bộ xả : BF455 - Bộ vòi : AS126C</p>	 <p>Technical drawing showing top view with dimensions: 1800 (length), 950 (width), 220V (voltage), 350 (depth), and 50 (drain diameter).</p>	 <p>Technical drawing showing side view with dimensions: 650 (height) and mounting points H and C.</p>
 <p>MT0770 - Bộ xả : BF455-75</p>	 <p>Technical drawing showing top view with dimensions: 1750 (length), 800 (width), 220V (voltage), and 50 (drain diameter).</p>	 <p>Technical drawing showing side view with dimensions: 450 (height), 600 (height), and mounting points H and C.</p>
 <p>MT5120 - Bộ xả : BF455</p>	 <p>Technical drawing showing top view with dimensions: 1220 (length), 1220 (width), 220V (voltage), 250 (depth), 50 (drain diameter), and 125 (corner radius).</p>	 <p>Technical drawing showing side view with dimensions: 580 (height) and mounting points H and C.</p>
 <p>AT5220 - Bộ xả : BF455</p>	 <p>Technical drawing showing top view with dimensions: 1220 (length), 750 (width), 1220 (width), 1240 (height), 280 (depth), and 50 (drain diameter).</p>	 <p>Technical drawing showing side view with dimensions: 530 (height), 420 (height), and mounting points H and C.</p>
 <p>MT5132 - Bộ xả : BF455</p>	 <p>Technical drawing showing top view with dimensions: 1380 (length), 1380 (width), 220V (voltage), 1400 (height), 50 (drain diameter), and 125 (corner radius).</p>	 <p>Technical drawing showing side view with dimensions: 580 (height) and mounting points H and C.</p>

MT5133
- Bộ xả : BF455-75

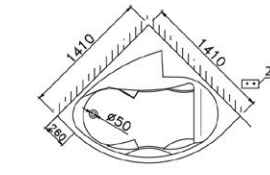
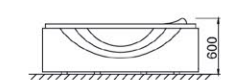
MT5140
- Bộ xả : BF455

MT5150
- Bộ xả : BF455

MT211L
- Bộ xả : 82600008
- Bộ vòi : 82850006

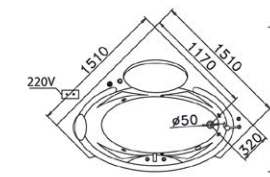
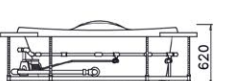
MT3370L
- Bộ xả : BF455
- Bộ vòi : AS127C

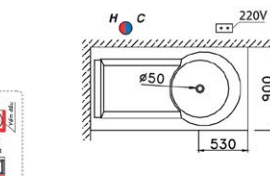
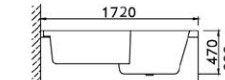
MT0870L
- Bộ xả : BF455-100
- Bộ vòi : AS127C

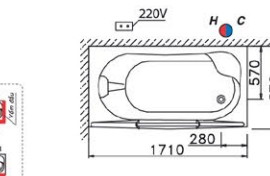
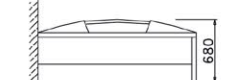
MT0150L / MT0170L
- Bộ xả : BF455

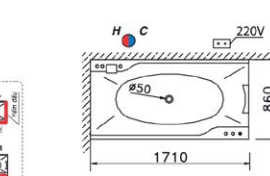
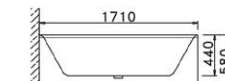
MT0250L / MT0270L
- Bộ xả : BF455

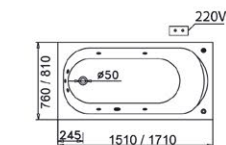
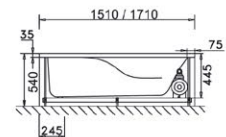
MT0350L / MT0370L
- Bộ xả : BF455

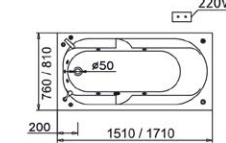
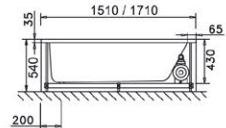
MT0550L / MT0570L
- Bộ xả : BF455

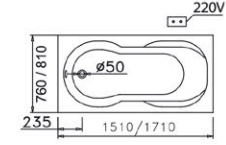
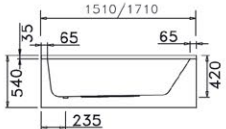

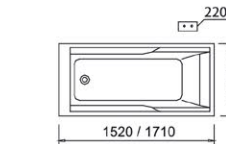
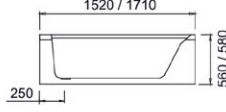

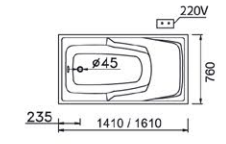
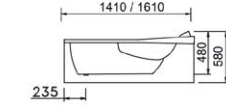
MT0440L / MT0460L
- Bộ xả : BF455

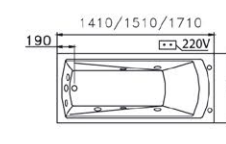
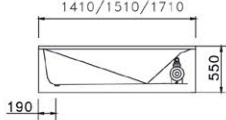

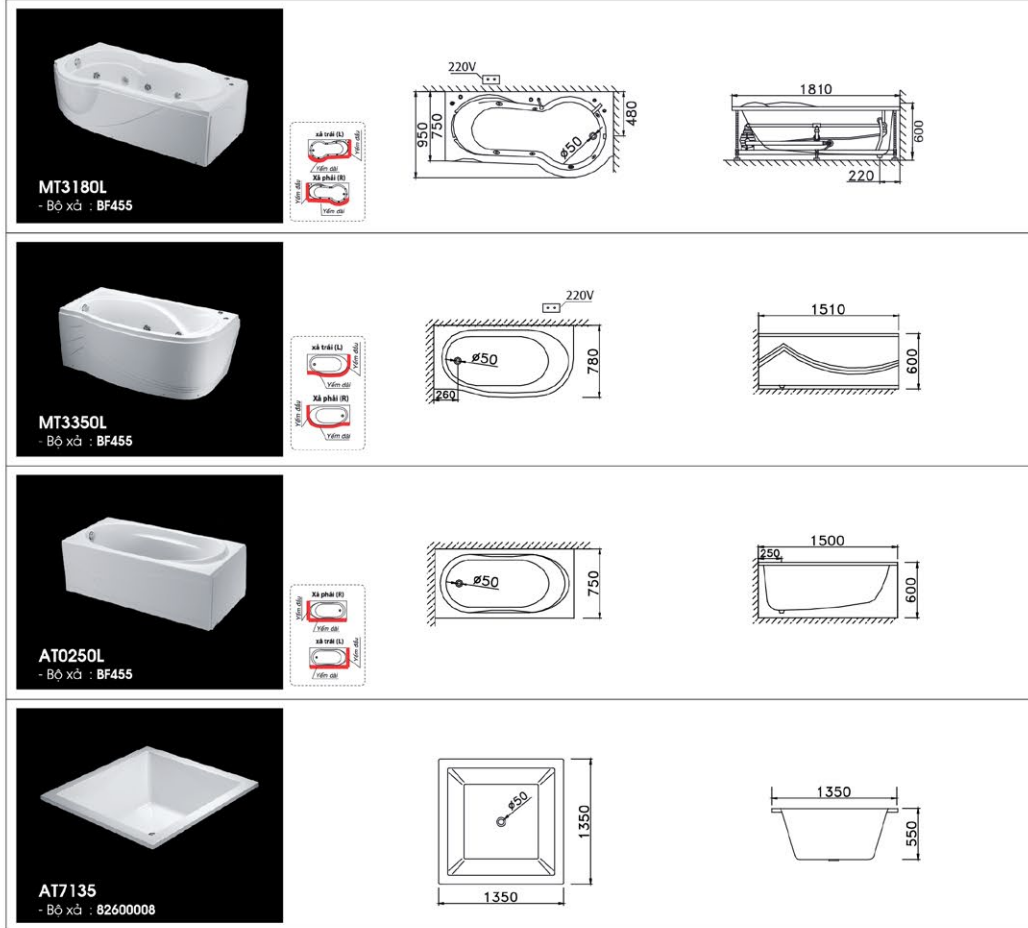

MT0640L / MT0650L / MT0670L
- Bộ xả : BF455

Bồn tắm

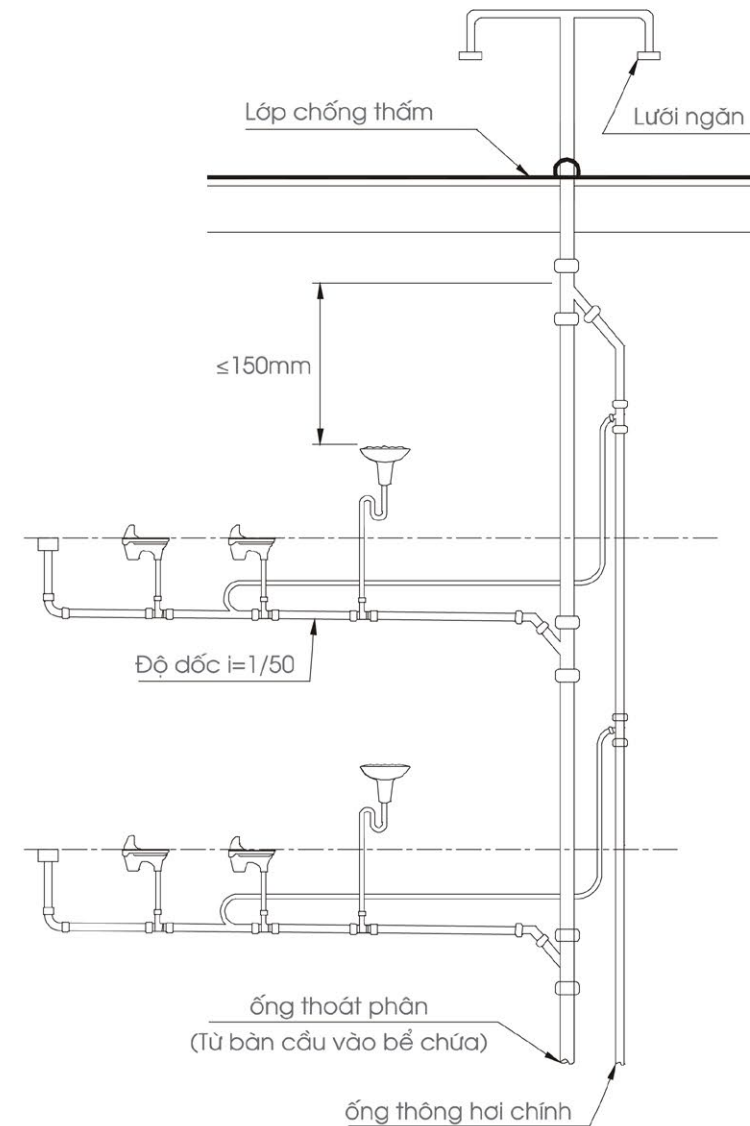

Tiêu chuẩn của ống thông hơi



Lưu ý :

Đối với các công trình không có ống thông hơi hoặc ống thông hơi bị nghẹt sẽ dẫn đến tình trạng xả không sạch hoặc bị mất nước chờ ngăn mùi gây mùi khó chịu trong phòng vệ sinh.

Phương pháp lắp đặt các loại bồn cầu

Cách lắp đặt ướt

- Đặt ống thoát phân (Ø114) lên mặt đất, dùng bao ny lon bọc lại phần lõi trên mặt đất để tránh tình trạng các mảnh phế liệu rơi vào đường ống, sau khi hoàn thành khâu lát gạch trang trí, xác định vị trí của ống thoát phân (Hình 1).
- Cắt ống thoát phân sao cho cao hơn nền hoàn thiện 1 cm (Hình 2).
- Đặt thử bồn cầu vào vị trí đảm bảo sao cho tâm lỗ thoát phân của bồn cầu đúng vào tâm và vẽ ra hình dạng phần chân cầu (Hình 3).
- Tráng một lớp xi măng rộng khoảng 3cm, chiều cao khoảng 1.5cm xung quanh bên trong đường viền phần chân cầu và bên ngoài ống thoát phân (Hình 4).
- Phải chắc chắn các phế liệu không rơi vào ống thoát phân.
- Đặt và điều chỉnh bồn cầu vào đúng vị trí lắp đặt, lau sạch phần xi măng xung quanh chân bồn cầu, sau đó lắp thùng nước vào thân cầu.
- Dùng silicon dán nắp chụp trang trí bằng nhựa che 2 lỗ bắt ốc của chân cầu lại (hình 6)

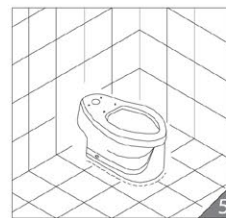
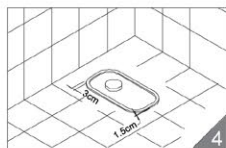
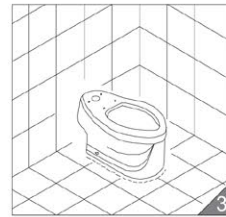
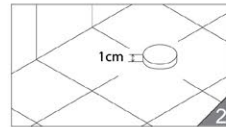
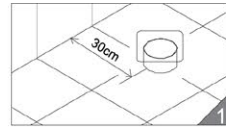

Nắp nhựa trang trí

Ghi chú :

- Không được tráng quá nhiều xi măng ở phần chân bồn cầu, công ty chúng tôi không chịu trách nhiệm về trường hợp xi măng quá dày dẫn đến tình trạng nứt bồn cầu.
- Lắp đặt đúng theo phương pháp hướng dẫn trên mà có xảy ra các lỗi như : xi hơi, trào nước, xả không sạch ... các lỗi liên quan đến sản phẩm. Công ty chúng tôi sẽ hoàn toàn chịu trách nhiệm.



Phương pháp lắp đặt các loại bồn cầu

Cách lắp đặt khô

- Trước khi lắp đặt bồn cầu, yêu cầu kiểm tra đầy đủ tất cả các dụng cụ và linh kiện cần thiết :

Dụng cụ lắp đặt	Số lượng	Công dụng
Cửa cắt hình cung	1 cái	Dùng cắt ống PVC
Máy khoan điện	1 cái	Khoan lỗ lắp cầu (mũi 3/8")
Búa sắt	1 cái	Đóng tắc kê
Dụng cụ xiết ốc	1 cái	Dùng xiết tắc kê
Công cụ xịt silicon	1 cái	Dùng xịt silicon
Silicon	1 ống	Trám viền chân cầu

- Sau khi đã hoàn thành khâu lát gạch trang trí, dùng cửa cắt ngắn ống thoát phân dưới nền còn lại 5mm, đường cắt phải bằng phẳng (Hình 1).
- Đặt bồn cầu vào vị trí lắp đặt sao cho tâm cầu trùng với ống thoát phân chờ sẵn trên sàn, làm dấu 2 lỗ bắt ốc trên chân cầu, sau đó lấy cầu ra và khoan 2 lỗ có đường kính 3/8", sâu 55mm ở vị trí vừa làm dấu (Hình 2).
- Đóng tắc kê vào lỗ đã khoan.
- Đặt nghiêng bồn cầu, tráng phốt dầu bên ngoài lỗ thoát phân của bồn cầu để khi lắp đặt hai ống thoát phân khít nhau (Hình 3).
- Lắp nhẹ bồn cầu vào, chú ý hai lỗ thoát phân thật khít nhau. Sau đó điều chỉnh chân cầu để khớp với tắc kê trên nền.
- Dùng vít 80mm xiết chặt vào tắc kê đã đặt trong sàn, bồn cầu đã lắp đặt xong, chụp nắp trang trí lên trên ốc (Hình 4).
- Lắp van chống chế nước lên ống dẫn nước trên tường theo chiều kim đồng hồ, nối dây dẫn cấp nước (bằng thau xi hoặc nhựa) với lỗ dẫn nước vào thùng nước. Trám 1 lớp silicon quanh chân cầu rộng khoảng 2cm (Hình 5).

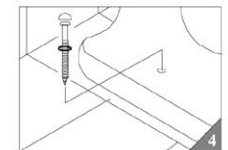
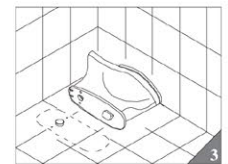
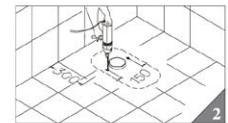
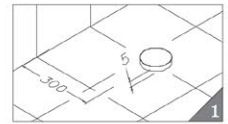

Bộ xả thùng nước đã được lắp đặt và kiểm tra 100% bằng nước trước khi xuất xưởng.

Phương pháp lắp đặt các loại bồn cầu xổm

Do thiết kế khác nhau của từng loại bồn cầu xổm mà chúng ta chọn ra phương pháp lắp đặt thích hợp. Sau đây là mộ số bước lắp đặt cơ bản

- 1 Trước khi lắp đặt bồn cầu, ta phải chuẩn bị tất cả loại vật dụng cần thiết cũng như mặt bằng thi công tối thiểu như kích thước hình 1
- 2 Đầu tiên ta lắp ống thoát phân, dựa vào đặc tính của từng loại cầu để chọn cách lắp đặt chừa ống cao hay chèn ống (như hình 2 và 3). Đường kính, độ dày ống thoát phân sẽ tùy thuộc vào từng loại cầu. Đối với loại ống có đường kính khoảng 100mm, độ dày ống không nên mỏng hơn 1/50cm (đồng thời dùng ống xi nối rộng đường kính của phần nhô lên sao cho vừa khít với lỗ thoát phân của bồn cầu). Do cấu tạo âm sàn của bồn cầu ta nên xây quanh nơi đặt cầu một lớp gạch cố định.
- 3 Chống thấm xung quanh phần tiếp xúc giữa bồn cầu và sàn bê tông hay sàn xi măng một lớp chống thấm như dầu hắc hay chất chống thấm có tính đàn hồi dày trên 3mm. Phải kiểm tra và chắc chắn rằng cầu, đường nước vào, ống thoát phân đã lắp đặt khít (Hình 4).
- 4 Sau khi tráng xong lớp xi măng cố định, ta lót các vật liệu gạch trang trí (Hình 5). Chú ý: khi đặt bồn cầu tiếp xúc trực tiếp với hỗn hợp bê tông, phải quét một lớp dầu hắc lên tất cả những phần tiếp xúc trực tiếp với hỗn hợp bê tông.

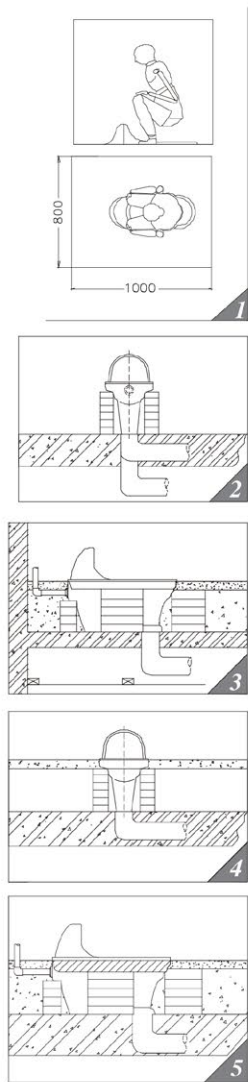

Những Điểm Cần Lưu ý

Tránh Làm Hư Bồn Cầu Khi Lắp Đặt

Do tính dễ co rút và cong nghiêng của bê tông nên nếu lắp đặt thiết bị trực tiếp lên hỗn hợp bê tông thì dễ dẫn đến tình trạng nứt hoặc hư cầu.

Công Ty Chúng Tôi Không Chịu Trách Nhiệm Cho Việc Lắp Đặt Sai Phương Pháp Này

Khuyến Cáo Khi Sử Dụng Bồn Cầu

- Không được dùng hoặc đặt vật nặng trên nắp bồn cầu
- Không được bỏ băng, vật dụng cá nhân, dụng cụ y tế ... vào lòng bồn cầu.



- Không được bỏ vật dụng, hóa chất... vào bên trong thùng nước



- Không được xô đẩy thùng nước vì sẽ làm gãy bulong kết nối giữa thùng nước và bồn cầu



- Không được bỏ vật trang trí hoặc vật dụng cá nhân để bề ... bên trên thùng nước

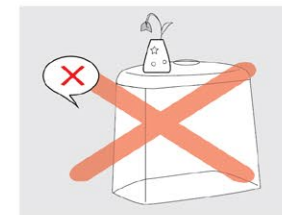

- Không lắp đặt sản phẩm trong vùng khí hậu lạnh khắc nghiệt dưới 0°C



- Không sử dụng hóa chất hoặc chất tẩy rửa ăn mòn ... để vệ sinh bồn cầu.



Một số sự cố và cách khắc phục thường gặp khi sử dụng bàn cầu

A : Bàn cầu một khối

Tình trạng	Nguyên nhân	Khắc phục
- Rỉ nước	- Do trụ cấp kẹt cát. - Do bể phốt	- Vệ sinh trụ cấp nước. - Thay phốt mới
- Không cấp nước	- Do lưới lọc bị nghẹt	- Vệ sinh lưới lọc
- Xả nước yếu	- Do khống chế chưa mở hết	- Điều chỉnh lượng nước cho thích hợp

B : Bàn cầu hai khối

Tình trạng	Nguyên nhân	Khắc phục
- Rỉ nước	- Do trụ cấp kẹt cát. - Do bể phốt - Do con cóc kẹt cát, cong	- Vệ sinh trụ cấp nước. - Thay phốt mới - Chỉnh hoặc thay con cóc
- Không cấp nước	- Do lưới lọc bị nghẹt	- Vệ sinh lưới lọc
- Xả nước yếu	- Do khống chế chưa mở hết	- Điều chỉnh lượng nước cho thích hợp

C : Bàn cầu với xả gạt tay (BF443, BF446, BF449)

Tình trạng	Nguyên nhân	Khắc phục
- Rỉ nước	- Do bể phốt	- Thay phốt mới
- Xả nước yếu	- Thi công đường nước sai	- Thi công lại đường nước cấp theo đúng yêu cầu
- Xả không sạch		
Chú ý :		
- Đối với loại cầu này bắt buộc thi công ống cấp nước chờ sẵn Ø34 răng trong, áp lực nước phải đạt : 1~4kg/cm ²		

Phương Pháp Lắp Đặt Lavabô Treo Tường và Chân Ngắn

- 1 Căn cứ theo kích thước trên bảng vẽ lắp đặt ta đánh dấu lên tường vị trí lỗ bắt ốc lắp lavabô.
- 2 Sử dụng tắc kê kim loại 100mm (có đinh kèm theo lavabô) : khoan hai lỗ có kích thước vừa với kích thước cỡ tắc kê, sau đó đóng tắc kê sâu vào tường.
- 3 Lắp vòi nước và bộ xả trên vào lavabô, lắp van khống chế nước trên tường (nhớ quấn cao su non xung quanh van để nước không rò rỉ).
- 4 Tháo phần ốc và lồng đèn của tắc kê ra. Đặt hai lỗ gắn tường của lavabô chính xác vào vị trí tắc kê đã đóng sẵn trên tường, dùng khóa 12 văng ốc và lồng đèn lại đến độ chặt thích hợp (không nên vặn ốc quá chặt để tránh làm rạn nứt phần sứ), đồng thời kiểm tra lần nữa xem đã lắp đặt chắc chắn chưa.
- 5 Lắp đặt ống thoát nước và ống thoát nước
- 6 Uớ m chân treo vào phần dưới lavabô và lấy dấu hai bên lỗ, cố gắng đặt cho chân treo và lavabô khít vào tường.
- 7 Khoan lỗ sâu 80mm, tiếp theo đóng tắc kê 70mm vào tường, sau đó lắp chân treo theo trình tự tương tự lắp lavabô.

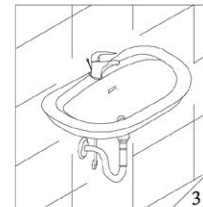
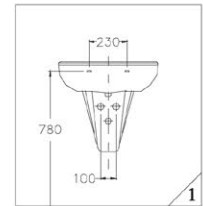

Phương Pháp Lắp Đặt

Lavabô Treo Tường và Chân Dài

- 1 Đặt chân đứng lavabô và đặt lavabô lên trên, căn thận dài toàn bộ đến vị trí tường dự định lắp đặt. Lấy dấu lỗ dự định lắp lavabô.
- 2 Sử dụng tắc kê kim loại 100mm (có đinh kèm theo lavabô) : khoan hai lỗ có kích thước vừa với kích thước cỡ tắc kê, sau đó đóng tắc kê sâu vào tường.



- Lắp vòi nước và bộ xả trên vào lavabô, lắp van khống chế nước trên tường (nhớ quấn cao su non xung quanh van để nước không rò rỉ).
- Tháo phần ốc và lông đến của tắc kê ra. Đặt hai lỗ gắn tường của lavabô chính xác vào vị trí tắc kê đã đóng sẵn trên tường, dùng khóa 12 vặn ốc và lông đến lại đến độ chặt thích hợp (không nên vặn ốc quá chặt để tránh làm rạn nứt phần sứ), đồng thời kiểm tra lần nữa xem đã lắp đặt chắc chắn chưa.
- Lắp đặt ống thoát nước và ống thoát nước.
- Uốn chân đứng vào phần dưới lavabô.

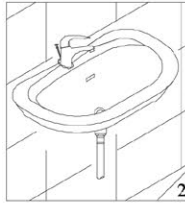

Hướng Dẫn Lắp Đặt Tủ Lavabô

- Trước tiên xác định chiều cao lắp đặt của tủ lavabô (từ nền hoàn thiện đến tủ khoảng 80cm, đồng thời đánh dấu vị trí bắt vít inox treo của tủ).
- Sau khi khoan lỗ tại vị trí đánh dấu, bắt vít inox treo vào tường.
- Treo tủ lên vít inox treo, điều chỉnh độ cao thấp của tủ. Sau đó làm dấu vị trí hai lỗ chờ sẵn trên pát inox, tháo tủ xuống khoan tường và bắt tắc kê nhựa vào.

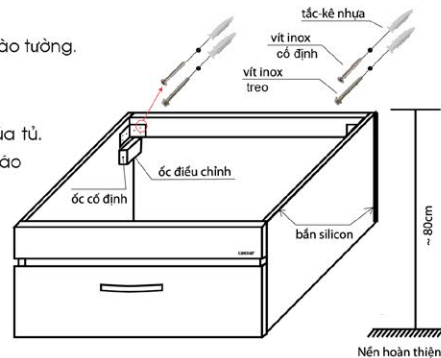

- Treo tủ lên vít inox treo cân chỉnh độ cao của tủ.
 - Vặn chặt ốc cố định tủ đồng thời bắt vít inox cố định để cố định tủ.
 - Lắp lavabô lên tủ :
 - Vị trí tiếp xúc giữa tủ và lavabô được cố định bằng silicon.
 - Vị trí tiếp xúc giữa tủ và tường kiến nghị cố định bằng silicon.
- * Chú ý : trước khi lắp đặt cần xác định ống thoát nước đã chính xác chưa.

Phương Pháp Lắp Đặt & Sử Dụng Bồn Tắm

Cách Lắp Đặt

- Kiểm tra kích thước, kiểu dáng, lỗ thoát nước thải trước khi lắp và xây khung đỡ theo (Hình 1)
- Đặt tủ bồn tắm vào lòng khung, điều chỉnh độ cân bằng của bồn bằng thước thủy, điều chỉnh ống thoát nước thải của bồn khớp với ống thoát nước đã chờ sẵn trên sàn hoặc trên tường.
- Kiểm tra độ hở hợp lý giữa đáy bồn và mặt sàn, ta lấy bồn ra để chống thấm sàn và xung quanh tường.
- Lắp bộ xả của bồn vào ống thoát nước trên sàn và tráng một lớp vữa xi măng bằng độ hở vừa đo được (Chú ý: không tráng xi măng xung quanh bộ xả kích thước 30x15cm như (Hình 3)), trên thành khung cũng tráng một lớp xi măng dày 0.3cm đến 0.5cm sau đó đặt bồn vào và cân bằng bằng thước thủy (Hình 4)
- Để tiện bảo trì sau này, ta chừa một ô bên vách như (Hình 2)
- Sau khi đã hoàn thành gạch trang trí, tiến hành chống thấm phần mép bồn tắm và thành khung bằng silicon (Hình 4).

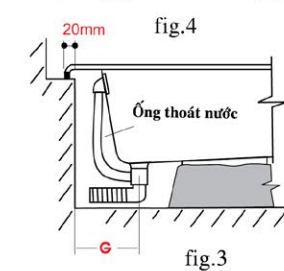
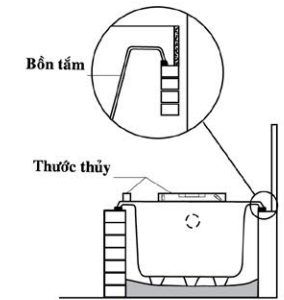
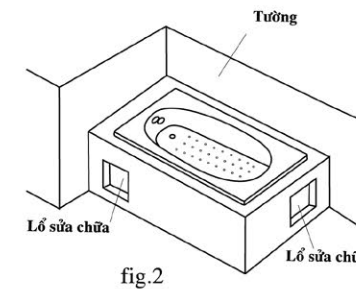
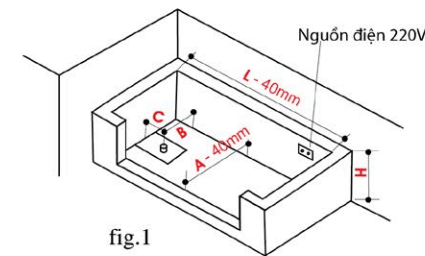

- A : Chiều rộng bồn tắm
 L : Chiều dài bồn tắm
 H : Chiều cao bồn tắm + chiều cao thoát nước
 B : Khoảng cách tâm thoát nước đến vách trước
 C : Khoảng cách tâm thoát nước của bồn tắm đến vách trái
 G : Khoảng cách tâm ống thoát nước của bộ xả đến vách trái

Các Điều Cần Lưu ý Khi Lắp Đặt :

- 1 Để tránh trượt nước trong suốt thời gian lắp đặt nên lót trên bề mặt bồn tắm một lớp bảo hay giấy mềm.
- 2 Trong trường hợp bị dính xi măng trên mặt bồn, rửa sạch bằng nước ngay khi xi măng còn ướt, không dùng vật cứng để cạo rửa.
- 3 Để đảm bảo tuổi thọ của bồn tắm, khi lắp đặt xong trong vòng một tuần không được chứa đầy nước hay sử dụng để tránh tình trạng nghiêng, lún.
- 4 Không mang giày dép bước vào bồn tắm.
- 5 Chú ý những vật liệu có thể gây tắc nghẽn ống thoát nước của bồn tắm.
- 6 Chú ý khi sử dụng máy mài, máy hàn quanh khu vực lắp bồn tránh các tia lửa hàn bay vào bồn tắm.
- 7 Tiêu chuẩn lắp đặt ở mỗi nơi có thể khác nhau nên hướng dẫn này mang tính tham khảo, nên để kỹ thuật viên chuyên nghiệp lắp đặt.

Các Điều Cần Lưu ý Khi Sử Dụng

⚠ Cảnh báo

Xác nhận có nối dây tiếp đất hay không

Sản phẩm chưa nối dây tiếp đất đúng cách có thể gây sự cố hoặc rò điện. Khi thi công dây tiếp đất xin liên hệ công ty lắp đặt chuyên nghiệp.



Nối với dây tiếp đất



Không dùng tay ướt chạm vào phích cắm điện, đó là nguyên nhân gây ra điện giật



Cấm tay ướt



Chú ý điện giật



Nghiêm cấm tự sửa chữa, tháo rời hoặc cài tiến sản phẩm này. Nếu không có khả năng dẫn đến bị điện giật hoặc hỏa hoạn, cũng có khả năng rò rỉ nước làm tài sản trong nhà bị hư hỏng hoặc vấy bẩn.



Nghiêm cấm tháo gỡ



Hãy vệ sinh định kỳ bị bẩn bám trên ổ cắm điện và đảm bảo ổ cắm được nối chặt vào nhau
Khi rút phích cắm hãy lau bằng khăn khô nếu không có thể xảy ra điện giật hoặc hỏa hoạn.



Cần thực hiện



Sử dụng đúng nguồn điện 220V, 60Hz. Nếu không, có thể xảy ra sự cố về điện hoặc cháy nổ.



Nghiêm Cấm

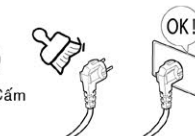

Khi rút phích cắm điện ra cần phải giữ chặt đầu cắm, nếu không chú ý kéo dây điện ra sẽ làm cho dây điện và phích cắm bị hư, gây ra chạm điện hoặc cháy nổ



Thực hiện đúng theo chỉ dẫn.



Cần kiểm tra nhiệt độ nước trước khi tắm, nếu không có thể bị bỏng



Chú ý nhiệt độ cao



Không nên sử dụng ổ cắm bị lỏng hoặc nguồn điện không ổn định, rất có thể gây chạm điện hoặc hỏa hoạn.



Nghiêm Cấm



Không tự ý tháo bỏ lưới lọc ở lỗ thoát nước tránh tình trạng tóc hay chất bẩn làm nghẹt ống nước.



Nghiêm Cấm



Không nên cho trẻ em tắm và chơi đùa một mình trong phòng tắm, phòng tắm ấm ướt dễ xảy ra sự cố đối với trẻ em.



Nghiêm Cấm



Khi sử dụng thiết bị chia nguồn, cần chú ý tránh sử dụng điện áp vượt quá quy định của thiết bị phân chia nguồn.



Nghiêm Cấm

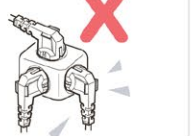

Chú ý đừng để vật cứng đè lên hoặc bề cong dây điện, vì có thể là nguyên nhân gây chạm điện và cháy nổ.



Nghiêm Cấm



Nếu muốn lắp đặt hoặc di chuyển bồn tắm, vui lòng liên hệ đơn vị cung cấp hoặc chuyên viên tiến hành xử lý. Tự ý di chuyển có thể sẽ gây ra chạm điện hoặc bị cháy, nếu bị rỉ nước sẽ ảnh hưởng đến tài sản của gia đình.



Thực hiện đúng



Những đối tượng sau không nên sử dụng chức năng của bồn tắm massage :

1. Phụ nữ mang thai.
2. Người sức khỏe yếu.
3. Những người bị bệnh tim mạch.
4. Người bị bệnh cao huyết áp.
5. Người đang say rượu.
6. Người uống thuốc ngủ.
7. Người được Bác sĩ cấm tắm trong bồn.



Nghiêm Cấm



Chú ý không được đứng trên cạnh của bồn tắm : nếu bất cẩn trượt ngã sẽ bị thương.



Nghiêm Cấm



Cấm lặn, chơi đùa trong bồn tắm, có thể dẫn đến chấn thương hoặc chết đuối.



Nghiêm Cấm



Khi ra vào bồn tắm xin cẩn thận tốt nhất là dùng tay vịn khi ra vào bồn tắm, nếu không cẩn thận có thể bị trượt sẽ gây thương tích.



Thực hiện đúng



Xin đừng sử dụng nước nóng trên 70°C, nếu nhiệt độ quá cao sẽ dẫn đến bề mặt bồn tắm biến dạng, có thể xuất hiện các vết nứt, đổi màu, rỉ nước hay những ảnh hưởng khác.



Nghiêm Cấm

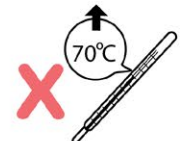

Kiểm tra và xác nhận các bộ phận kết nối có vững chắc hay chưa và kiểm tra luôn phần rò rỉ. (Chỉ mỗi nối không chắc để gây hao mòn, hư hỏng, máy móc không thể hoạt động hoặc rỉ nước và gây thiệt hại về tài sản.)



Thực hiện đúng



Không lắp đặt bồn tắm ở nơi nhiệt độ quá thấp

Nếu đường ống bị đóng băng sẽ làm đường ống bị hư, trực tiếp hoặc rò rỉ điện.



Tránh để vật cứng rơi vào bồn tắm hoặc va chạm với bồn tắm.



Bồn tắm bị nứt có thể dẫn đến bị thương, rò rỉ nước gây thiệt hại những tài sản trong nhà.



Lưu ý không nên để nước trong bồn tắm tràn ra ngoài



Nước tràn có thể gây hư hỏng sàn nhà, phòng tắm ướt dễ bị mốc hoặc bị thương do trượt ngã.



Xin đừng đổ dung dịch có tính ăn mòn vào lỗ thoát nước bồn tắm, đường ống có thể bị ăn mòn và gây nên tình trạng rỉ nước.



Cách Xử Lý Sự Cố Đơn Giản

Khi Sử Dụng Bàn Cầu Nắp Điện Tử

Trước khi báo bảo trì sản phẩm lưu ý các trường hợp sau :

Tình Trạng	Nguyên Nhân
Chức năng vệ sinh không có nước chảy ra	<ul style="list-style-type: none"> • Đã có nguồn cấp chưa ? • Van khóa chế đang khóa ? • Lọc nước bị nghẹt ?
Các chức năng của sản phẩm đều không hoạt động	<ul style="list-style-type: none"> • Cúp điện hoặc ngắt nguồn điện ? • Đèn hiển thị đều tắt hết ? • Nếu chưa ngồi lên thiết bị cảm ứng sẽ không hoạt động
Nước rửa vệ sinh ra yếu	<ul style="list-style-type: none"> • Mức nước rửa vệ sinh được điều chỉnh ở mức thấp nhất ? • Có dị vật gây tắc nghẽn ở lưới lọc ? • Van khóa chế chưa được mở hoàn toàn ?
Rỉ nước	<ul style="list-style-type: none"> • Kiểm tra ống nước đã được kết nối tốt, không rỉ nước, nếu rỉ nước từ thân sản phẩm, hãy liên hệ với cửa hàng nơi bạn mua sản phẩm để tiến hành kiểm tra, sửa chữa.
Nhiệt độ nước rửa hoặc nắp ngồi quá thấp	<ul style="list-style-type: none"> • Nhiệt độ nước hoặc nắp ngồi đang ở chế độ tắt hoặc ở mức thấp nhất ?
Đầu phun không đưa ra	<ul style="list-style-type: none"> • Sau khi ngồi đúng chỗ, nhấn nút rửa vệ sinh mà vẫn không hoạt động, hãy liên hệ với nơi bạn mua sản phẩm để được kiểm tra và sửa chữa
Thân sản phẩm rung lắc	<ul style="list-style-type: none"> • Khóa chặt ốc cố định (xem phần hướng dẫn lắp đặt)

Hướng Dẫn An Toàn

Khi Sử Dụng Bàn Cầu Nắp Điện Tử

Tuân Thủ Chặt Chẽ

Làm đúng theo cảnh báo an toàn để tránh gây ra tổn hại sức khỏe và tài sản. Nắm rõ các biểu tượng cảnh báo dưới đây và tuân thủ chặt chẽ các cảnh báo an toàn

Cảnh Báo	Nguy hiểm lập tức và bức thiết, nếu không tránh ngay có thể gây tổn thương nghiêm trọng	Chú Ý :	Nếu bỏ qua hướng dẫn thao tác này, có thể gây tổn thương nhẹ hoặc hư hỏng sản phẩm
	Nghiêm Cấm		Phải đảm bảo nguồn điện được tắt nếu không sử dụng trong thời gian dài
	Cấm Tháo hoặc cài tạo sản phẩm		Không được ngâm trong nước
	Lắp đặt dây tiếp đất để tránh bị điện giật		Chú ý các điều khoản sau
	Tránh tiếp xúc bằng tay ướt		

⚠ CẢNH BÁO

Khi chưa lắp thân sản phẩm hoặc chưa kết nối ống cấp, không cắm phích điện vào ổ cắm



Nếu sản phẩm có vấn đề sau, hãy ngưng sử dụng và rút ổ cắm ra, khóa van không chế, nếu tiếp tục sử dụng có thể xảy ra hỏa hoạn, điện giật hoặc rỉ nước, hãy liên hệ với nơi bạn mua sản phẩm để được kiểm tra và sửa chữa

- * Sản phẩm / ống cấp rỉ nước
- * Sản phẩm bốc khói
- * Sản phẩm gia nhiệt bất thường
- * Có âm thanh lạ hoặc mùi lạ
- * Bị nứt hoặc bể vỡ



Rút nguồn điện



Sử dụng nguồn điện 220V / 60Hz, ổ cắm điện điện áp > 220V hoặc sử dụng thiết bị chia nguồn hoặc dây nối, có thể gây hỏa hoạn hoặc điện giật.



Chú Ý

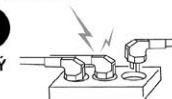

Không để sản phẩm trong nước nếu không sẽ gây hư hỏng sản phẩm hoặc giật điện.



Không để trong nước



Khi bàn cầu đang xả nước, sử dụng chức năng rửa vệ sinh sẽ ảnh hưởng đến áp suất nước rửa vệ sinh. Ở nơi có áp suất thấp, có thể làm cho đầu phun của sản phẩm không thể hoạt động. Sử dụng nguồn nước sạch. Sử dụng nguồn tuabin hoặc nước công nghiệp có thể sẽ gây ra viêm bàng quang hoặc viêm da.



Sử dụng nguồn nước sạch



Không dùng dây điện nguồn hoặc ổ cắm bị hỏng. Nếu không có thể gây điện giật, chạm mạch hoặc hỏa hoạn



Nghiêm Cấm



Không tự ý tháo, thay đổi hoặc tự sửa chữa sản phẩm, có thể gây hỏa hoạn, điện giật hoặc tổn thương, hãy liên hệ với nơi bạn mua sản phẩm để được kiểm tra và sửa chữa



Cấm Tháo Lắp



Giữ cho thân sản phẩm và ổ cắm điện nguồn khô ráo. Nếu không có thể gây hỏa hoạn hoặc điện giật.



Nghiêm Cấm



Cắm dây điện vào ổ cắm an toàn. Nếu không có thể gây ra điện giật, chạm mạch, phát ra tia lửa hoặc hỏa hoạn.



Cắm phích điện an toàn



Khi tay bị ướt tuyệt đối không cầm hoặc rút phích điện nguồn. Nếu không có thể gây ra điện giật.



Không chạm phích điện khi tay ướt



Khi vệ sinh sản phẩm phải rút dây điện nguồn. Nếu không có thể gây điện giật hoặc tổn thương.



Rút Nguồn Điện

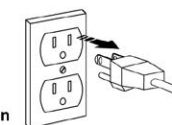

Sản phẩm không để gần bếp lửa, thiết bị gia nhiệt hoặc nhang, thuốc là đang cháy. Nếu không có thể gây ra hỏa hoạn, sản phẩm bị đổi màu hoặc hư hỏng.



Nghiêm Cấm



Không dùng sức đóng nắp bàn cầu hoặc nắp ngồi (Không dùng lực để mạnh xuống)



Nghiêm Cấm



Không đứng lên sản phẩm hoặc tạo áp lực lên sản phẩm, sẽ gây biến dạng, hư hỏng, dẫn đến tổn thương



Nghiêm Cấm



Không để nước tiểu dính lên đầu phun, sẽ gây ra mùi hôi hoặc dẫn đến sự cố, khi đầu phun dính phải dị vật, cần làm sạch bằng bàn chải lông mềm.



Cảnh Báo



